

**Dema**  
FIRENZE

DIVANI+COMPLEMENTI+DIVANI LETTO

**Dema**  
FIRENZE

**Dema**  
FIRENZE

**IT.**DEMA VIENE FONDATA NEL 1962 A SAN GIMIGNANO, NEL CUORE DELLA TOSCANA. GLI INTENTI DELL'AZIENDA SONO STATI CHIARI FIN DAGLI INIZI: PRODURRE DIVANI DI ALTO CONTENUTO TECNICO, SVILUPPARE UNA CONTINUA RICERCA ESTETICA E PORRE LA FUNZIONALITÀ E LA QUALITÀ COME VALORI FONDANTI DELLA STRATEGIA AZIENDALE. QUESTA DETERMINAZIONE, HA PORTATO DEMA AD AFFERMARSI AUTOREVOLMENTE NEL MERCATO ITALIANO ED INTERNAZIONALE DEGLI IMBOTTITI DI ALTA GAMMA, CON PROPOSTE INNOVATIVE ED INEDITE.

**EN.**DEMA WAS FOUNDED IN 1962 IN SAN GIMIGNANO, IN THE VERY HEART OF TUSCANY AND ITS OBJECTIVES WERE CLEAR FROM THE VERY BEGINNING: THE PRODUCTION OF HIGHLY TECHNICAL SOFAS, CONSTANT RESEARCH INTO DESIGN, AND SETTING FUNCTIONALITY AND QUALITY AS THE CORE VALUES OF THE COMPANY STRATEGY. THIS DETERMINATION ENABLED DEMA TO ASSURE ITSELF AS A LEADER BOTH IN ITALY AND ABROAD FOR TOP QUALITY UPHOLSTERED FURNITURE, WITH UNIQUE AND INNOVATIVE IDEAS.

**FR.**DEMA A ÉTÉ FONDÉE EN 1962 À SAN GIMIGNANO DANS LE CŒUR DE LA TOSCANE. LE BUT DE L'ENTREPRISE A ÉTÉ CLAIR DÈS LE DÉBUT : PRODUIRE DES CANAPÉS À HAUTE TECHNICITÉ, DÉVELOPPER UNE RECHERCHE ESTHÉTIQUE CONTINUE ET METTRE LA FONCTIONNALITÉ ET LA QUALITÉ COMME DES VALEURS FONDAMENTALES DE LA STRATÉGIE D'ENTREPRISE. CETTE DÉTERMINATION A MENÉ DEMA À S'AFFIRMER AVEC AUTORITÉ SUR LE MARCHÉ ITALIEN ET INTERNATIONAL DE LA SELLERIE HAUT DE GAMME, AVEC DES IDÉES NOVATRICES ET INÉDITES.

**DE.**DAS UNTERNEHMEN DEMA WURDE IM JAHR 1962 IN SAN GIMIGNANO IM HERZEN DER TOSKANA GEGRÜNDET. DIE ABSICHTEN DES UNTERNEHMENS WAREN VON ANFANG AN KLAR: HERSTELLUNG VON TECHNISCH ANSPRUCHSVOLLEN SOFAS SOWIE AUSBAU EINER KONTINUIERLICHEN ÄSTHETISCHEN FORSCHUNG, WOBEI FUNKTIONALITÄT UND QUALITÄT DER FIRKENSTRATEGIE ALS WESENTLICHE ELEMENTE ZUGRUNDE GELEGT WURDEN. DURCH DIESE BESTIMMTHEIT KONNTE SICH DAS UNTERNEHMEN DEMA MIT INNOVATIVEN UND NEUARTIGEN MODELLEN MASSGEBLICH AUF DEM ITALIENISCHEN UND INTERNATIONALEN MARKT DER SPITZEN-POLSTERMÖBEL BEHAUPTEN.

# L'azienda



**IT.** LA FILIERA PRODUTTIVA È TUTTA INTERNA ALL'AZIENDA E QUESTA SCELTA CONSENTE IL CONTROLLO E IL MANTENIMENTO COSTANTI DEGLI ALTI STANDARD QUALITATIVI CHE DEMA SI È POSTA. LA FASE IN CUI MEGLIO SI ESPRIME IL VALORE DEL "SAPER FARE" AZIENDALE È LA LAVORAZIONE DEI RIVESTIMENTI, CHE SI CONFIGURA COME UNA ATTIVITÀ DI SARTORIA SU MISURA, PUR ALL'INTERNO DI UN RIGOROSO PROCESSO DI CARATTERE INDUSTRIALE. OGNI SINGOLO RIVESTIMENTO VIENE REALIZZATO CON L'AIUTO DI MACCHINE TECNOLOGICAMENTE AVANZATE, MA RIFINITO AD ARTE GRAZIE ALLA PROFONDA MANUALITÀ ARTIGIANA CHE È DA SEMPRE E TUTTORA PATRIMONIO PREZIOSO DI DEMA.

**EN.** ALL PRODUCTION STAGES ARE CARRIED OUT INTERNALLY: THIS CHOICE ALLOWS THE HIGH QUALITY STANDARDS THAT DEMA HAS SET ITSELF TO BE CONSTANTLY CONTROLLED AND MAINTAINED. THE VALUE PLACED BY THE COMPANY ON "KNOW-HOW" COMES TO THE FORE IN THE UPHOLSTERY, CREATED BY EXPERT CRAFTSMEN WITHIN THE PRODUCTION PROCESS WHICH IS OTHERWISE STRICTLY INDUSTRIAL. ALL UPHOLSTERY COMPONENTS ARE MADE USING STATE-OF-THE-ART MACHINERY AFTER WHICH THEY ARE SUPERBLY FINISHED BY OUR EXPERT CRAFTSMEN, WHO HAVE ALWAYS BEEN CONSIDERED PRECIOUS ASSETS AT DEMA.

**FR.** LE PROCESSUS DE PRODUCTION EST ENTIÈREMENT INTERNE À L'ENTREPRISE ET CE CHOIX PERMET DE CONTRÔLER ET DE MAINTENIR DES NORMES UNIFORMES DE HAUTE QUALITÉ QUE DEMA A FIXÉ. L'ÉTAPE QUI EXPRIME AUX MIEUX LA VALEUR DU « SAVOIR-FAIRE » DE L'ENTREPRISE EST LA FABRICATION DES REVÊTEMENTS, QUI EST CONFIGURÉE COMME UNE ENTREPRISE DE CONFECTION SUR MESURE, TOUT EN OBSERVANT UN PROCESSUS RIGOUREUX DE L'INDUSTRIE. CHAQUE REVÊTEMENT EST FAIT À L'AIDE DE MACHINES TECHNOLOGIQUEMENT AVANCÉES, MAIS EST FINI À L'ART GRÂCE À LA MINUTIEUSE CAPACITÉ DE L'ARTISAN QUI EST DEPUIS TOUJOURS LA VALEUR AJOUTÉE DE DEMA.

**DE.** DIE PRODUKTIONSLINIE LÄUFT VOLLKOMMEN FIRMENINTERN AB. DIESE ENTSCHEIDUNG ERMÖGLICHT DIE KONTROLLE UND DIE KONSTANTE AUFRECHTERHALTUNG DER HOHEN QUALITÄTSSTANDARDS, DIE SICH DAS UNTERNEHMEN DEMA AUFERLEGT HAT. DIE PHASE, IN DER SICH DER WERT DES „FIRMENKÖNNENS“ AM BESTEN AUSDRÜCKT, IST DIE BEARBEITUNG DER BEZÜGE, DIE SICH WIE DIE TÄTIGKEIT EINER MAßSCHNEIDERWERKSTÄTTE GESTALTET, OBWOHL SIE INNERHALB EINES STRENGEN PROZESSES MIT INDUSTRIEEIGENSCHAFTEN ABLÄUFT. JEDER EINZELNE BEZUG WIRD MIT HILFE VON MASCHINEN REALISIERT, DIE TECHNOLOGISCH IHRER ZEIT VORAUSSIND UND DANK EINER AUSGEPRÄGTEN HANDWERKLICHEN GESCHICKLICHKEIT, DIE SEIT JEHER UND HEUTE NOCH EIN KOSTBARES GUT DES UNTERNEHMENS DEMA DARSTELLT, KUNSTGEREICHT FEINVERARBEITET.

## La sartoria



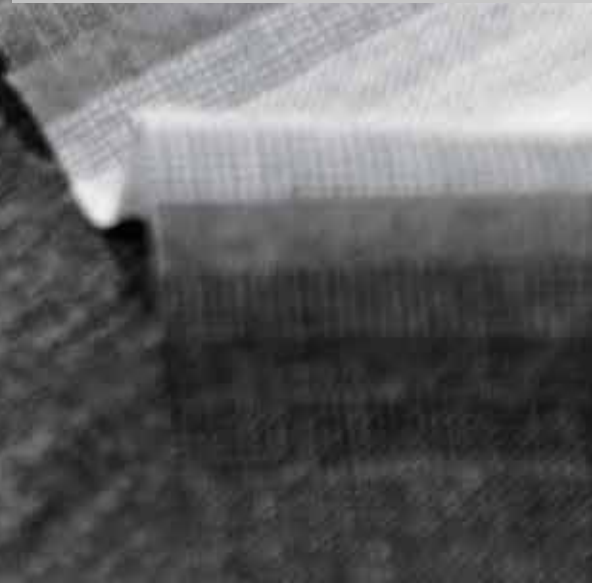
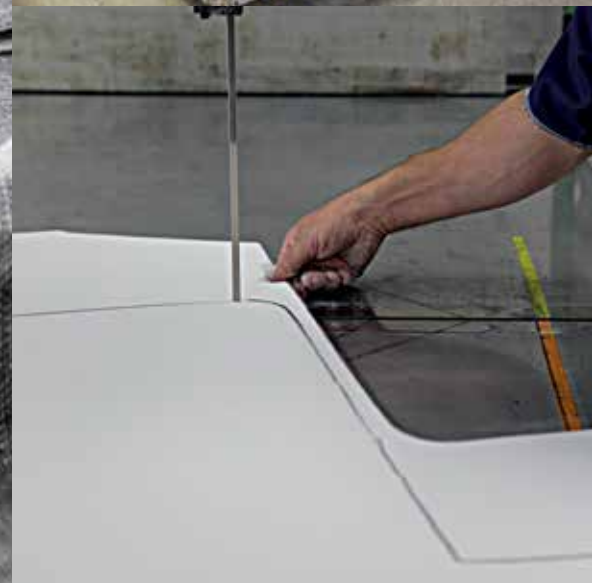
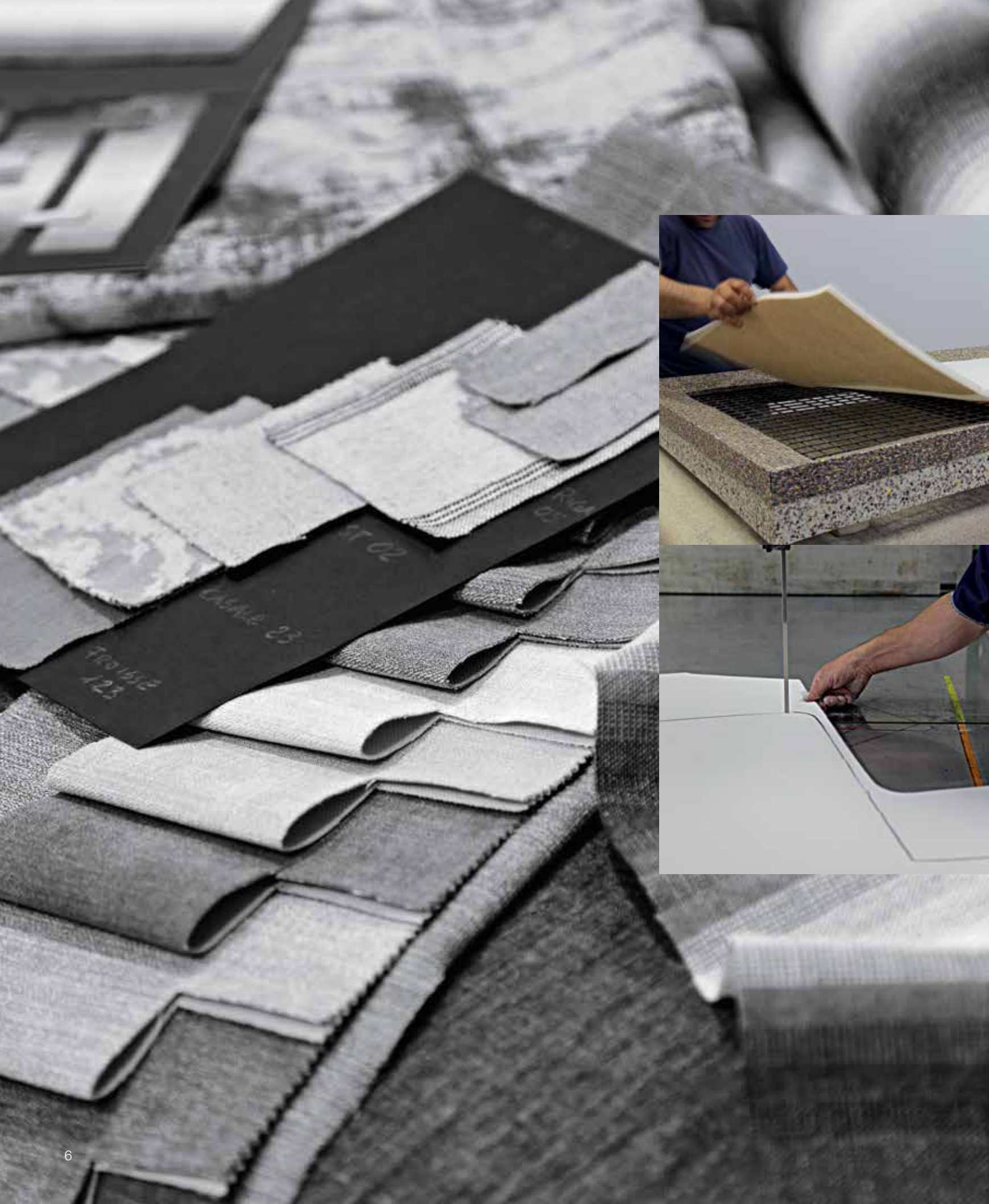

**IT.** CREATIVITÀ E FUNZIONALITÀ SONO LE COMPONENTI COSTITUTIVE DEL DESIGN ED ENTRAMBE SI DEVONO CONFRONTARE CON I MATERIALI, DAI QUALI ESTRARRE IL MASSIMO DELLE PRESTAZIONI E DELLE POTENZIALITÀ. IL "PROGETTO DIVANO" DI DEMA TROVA IL SUO ELEMENTO STRUTTURALE NEL METALLO TUBOLARE, CHE CONFERISCE ROBUSTEZZA E LEGGEREZZA INSIEME. L'INTEGRAZIONE CON IL POLIURETANO ESPANSO DELLE IMBOTTITURE CONSENTE POI DI REALIZZARE LINEE INEDITE E FORME AUDACI. I RIVESTIMENTI CHE COMPLETANO IL PRODOTTO FINITO CON TESSUTI O PELLI SONO IN LINEA CON LA COSTANTE EVOLUZIONE DELLE TENDENZE DELL'ARREDO INTERNAZIONALE.

**EN.** DESIGN NEEDS TO BE BOTH CREATIVE AND FUNCTIONAL, ALSO IN VIEW OF THE MATERIALS USED WHICH NEED TO BE EXPLOITED TO THE FULL FOR TOP PERFORMANCE. THE STRUCTURAL ELEMENT IN DEMA'S "SOFA PROJECT" IS TUBULAR METAL WHICH IS BOTH STURDY AND LIGHTWEIGHT. THE ADDITION OF EXPANDED POLYSTYRENE TO THE PADDING MAKES IT POSSIBLE TO CREATE ORIGINAL DESIGNS AND BOLD SHAPES. THE UPHOLSTERY IN FABRIC OR LEATHER REPRESENTS THE STATE OF THE ART IN INTERNATIONAL FURNITURE DESIGN.

**FR.** LA CRÉATIVITÉ ET LA FONCTIONNALITÉ SONT LES ÉLÉMENTS CONSTITUTIFS DE LA CONCEPTION ET LES DEUX SONT CONFRONTÉS À DES MATÉRIAUX À PARTIR DESQUELS TIRER LE MAXIMUM DE LA PERFORMANCE ET DU POTENTIEL. LE « PROJET CANAPÉ » DE DEMA TROUVE SON ÉLÉMENT STRUCTUREL DANS LE TUBE DE MÉTAL, QUI DONNE À LA FOIS DE LA FORCE ET DE LA LÉGÈRETÉ. L'INTÉGRATION AVEC REMBOURRAGE EN MOUSSE POLYURÉTHANE EXPANSÉ PERMET ALORS DE RÉALISER DES LIGNES NON CONVENTIONNELLES ET DES FORMES AUDACIEUSES. LES REVÊTEMENTS QUI COMPLÈTENT LE PRODUIT FINI EN TISSU OU CUIR SONT EN LIGNE AVEC L'ÉVOLUTION CONSTANTE DES TENDANCES INTERNATIONALES DANS LE MOBILIER.

**DE.** KREATIVITÄT UND FUNKTIONALITÄT SIND DIE BESTIMMENDEN KOMPONENTEN DES DESIGNS UND BEIDE MÜSSEN SICH MIT MATERIALIEN MESSEN, AUS DENEN MAXIMALE LEISTUNGEN UND MÖGLICHKEITEN GEWONNEN WERDEN SOLLTEN. DAS „PROJEKT SOFA“ VON DEMA FINDET SEIN STRUKTURELEMENT IM METALLROHR, DAS STRAPAZIERFÄHIGKEIT UND GLEICHZEITIG LEICHTIGKEIT VERLEIHT. DIE ERGÄNZUNG MIT PU-SCHAUM FÜR DIE POLSTERUNGEN ERMÖGLICHT DIE AUSFÜHRUNG VON NEUARTIGEN UND GEWAGTEN FORMEN. DIE BEZÜGE AUS STOFF ODER LEDER, DIE DAS ENDPRODUKT VERVOLLSTÄNDIGEN, BEFINDEN SICH AUF EINER LINIE MIT DER KONSTANTEN WEITERENTWICKLUNG DER TENDENZEN DER INTERNATIONALEN EINRICHTUNG.

# La materia





**IT.** IL "TOTAL COMFORT" È LA FINALITÀ ULTIMA A CUI IL DESIGN DEL DIVANO DEVE TENDERE. DEMA RAGGIUNGE E REALIZZA QUESTO OBIETTIVO INTEGRANDO FORME ACCOGLIENTI E AVVOLGENTI A SOLUZIONI TECNICHE ORIGINALI E A MATERIE DI GRANDE USABILITÀ. DA QUESTA SAPIENTE COMBINAZIONE NASCONO PRODOTTI CHE HANNO SEMPRE UNA FORTE PERSONALITÀ ESTETICA, MA NON RINUNCIANO A PROPORSI COME LUOGO E STRUMENTO DI VERO RELAX, FUNZIONE PRIMARIA DEL DIVANO. GRAZIE ALL'APPORTO CREATIVO E PROGETTUALE DEI SUOI DESIGNER, DEMA ESPRIME UN CATALOGO CHE RISPONDE ALLE SOLLECITAZIONI E ALLE RICHIESTE DELLA CLIENTELA PIÙ ESIGENTE.

**EN.** THE ULTIMATE GOAL OF ANY SOFA DESIGN IS THE CONCEPT OF "TOTAL COMFORT". DEMA ACCOMPLISHES THIS OBJECTIVE BY COMBINING ATTRACTIVE, COMFORTABLE SHAPES WITH ORIGINAL TECHNICAL SOLUTIONS AND EXTREMELY HARD-WEARING MATERIALS. THIS SKILFUL COMBINATION LEADS TO THE CREATION OF PRODUCTS THAT NOT ONLY HAVE GREAT LOOKS AND PERSONALITY BUT ARE ALSO A PLACE AND AN INSTRUMENT OF TRUE RELAXATION, THE PRIMARY FUNCTION OF ANY SOFA. THE CREATIVITY OF ITS DESIGNERS ALLOWS DEMA TO PRODUCE A RANGE WHICH MEETS ALL THE WISHES AND NEEDS OF ITS MOST DEMANDING CLIENTELE.

**FR.** LE « CONFORT TOTAL » EST LE BUT ULTIME QUE LA CONCEPTION DU CANAPÉ DOIT S'EFFORCER D'ATTEINDRE. DEMA ATTEINT ET RÉALISE CET OBJECTIF EN INTÉGRANT DES FORMES CONFORTABLES ET DES SOLUTIONS TECHNIQUES ORIGINALES ET DES MATÉRIAUX D'UNE GRANDE FACILITÉ D'UTILISATION. DE CETTE COMBINAISON INTELLIGENTE NAISSENT DES PRODUITS QUI ONT TOUJOURS UNE FORTE PERSONNALITÉ ESTHÉTIQUE, SANS RENONCER DE SE PROPOSER COMME UN INSTRUMENT DE VRAI RELAX, QUI EST LA FONCTION PRIMAIRE RÉELLE DU CANAPÉ. GRÂCE À LA CONCEPTION CRÉATIVE DE SES CONCEPTEURS, DEMA EXPRIME UN CATALOGUE QUI RÉPOND AUX EXIGENCES ET AUX BESOINS DES CLIENTS LES PLUS EXIGEANTS.

**DE.** DER „TOTAL COMFORT“ IST DIE HÖCHSTE ZIELSETZUNG, NACH DER DAS DESIGN DES SOFAS STREBEN MUSS. DAS UNTERNEHMEN DEMA ERREICHT UND REALISIERT DIESE ZIELSETZUNG DURCH VERVOLLSTÄNDIGUNG GEMÜTLICHER UND UMHÜLLENDER FORMEN UND ORIGINELLER TECHNISCHER LÖSUNGEN MIT MATERIALIEN GROßER NUTZBARKEIT. AUS DIESER GESCHICKTEN KOMBINATION ENTSTEHEN PRODUKTE, DIE STETS ÜBER EINE STARKE ÄSTHETISCHE PERSÖNLICHKEIT VERFÜGEN, JEDOCH NICHT DARAUf VERZICHTEN, SICH ALS ORT UND INSTRUMENT DER WAHREN ENTSPANNUNG ANZUBIETEN – DIE WICHTIGSTE FUNKTION EINES SOFAS. DANK DES KREATIVEN UND PLANERISCHEN BEITRAGS SEINER DESIGNER ÄUßERT SICH DAS UNTERNEHMEN DEMA IN EINEM KATALOG, DER DEN NACHFRAGEN UND DEN ANSPRÜCHEN DER ANSPRUCHSVOLLSTEN KUNDEN NACHKOMMT.

## Il design



ALTOBASSO PLUS 154



BABILONIADUE 120



BOSS 108



DYNAMIC PLUS 162



DUDE 12



FLY 30



FLY LIGHT 46



GIASONE 218



LE FOGLIE 184



LE ONDE 84



MILORD 210



MODULOR 132



NEWPORT 94



OTTOMANNE 202



RATAPLAN 194



RIALTO 144



SCACCO 172



SLIM 58



VELIERO 70



ARNOLD 237



BETTY 238



BOULE 230



CUCCIA 239



DADA 234



DAM 235



ELETTRA 232



ELIO 241



FLÛTE 231



LIBERO 240



LIPS 229



MANHATTAN 236



MEDIUM LIPS 228



MIAMI 233



CUBIC 242



CUBO 244



CUSCINI 254



DECK 246



DUDE 248-249-250



HOTELLO 245



KUADRO 247



PET'S BED 252



ROUND 251



SANDY 253



SIMPLE 243

Collezione Dema divani+complementi

Design  
G. GUALTIEROTTI



**Dude**



























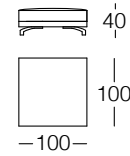

Basi . Base units  
Bases . Unterbauten

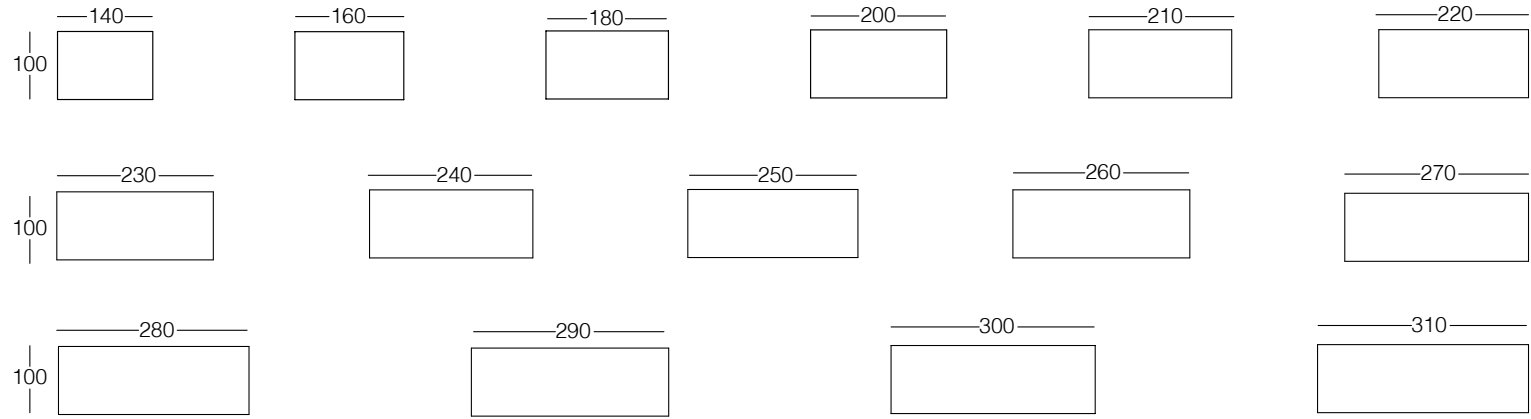

Schienale  
Backrest  
Dossier  
Rückenlehne

Cuscini seduta  
Seat cushions  
Coussins d'assise  
Sitzkissen

Cuscini pouff  
Pouf cushions  
Coussins pouff  
Polsterelment

Cuscini schienali piuma  
Backrest cushions, filled with feathers  
Coussins pour dossiers en plume  
Rückenpolster aus Gänsedaunen

Bracciolo  
Armrest  
Accoudoir  
Armlehne

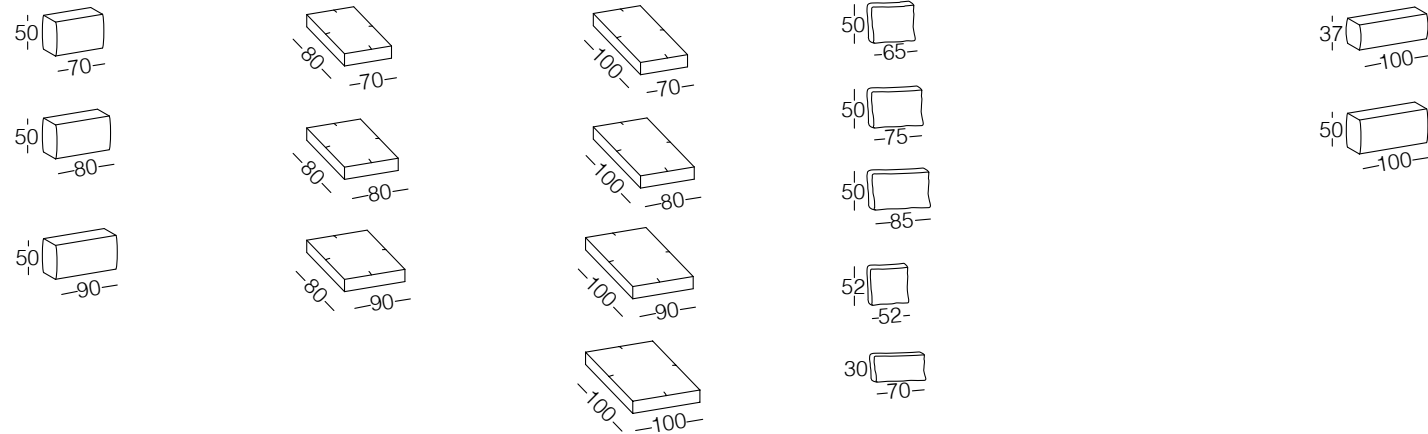

**Elementi composti, consultare listino . For modular elements, see price list .**  
**Éléments composites, consulter le tableau des prix . Für Kombinationen verweisen Sie auf die Preisliste**

**IT** \_Struttura basi, braccioli e schienali in acciaio verniciato garantita 10 anni. Imbottitura in schiuma poliuretana a quote differenziate e rivestita in fibra acrilica accoppiata. Seduta in poliuretano espanso a quote differenziate con memory foam e fibra acrilica rivestiti con tela di cotone bianca. Cuscini volanti schienali in piuma d'oca canalizzata. Tavolini in marmo, travertino e cuoio con anima in multistrato. Pet's bed: struttura in multistrato gommato rivestita in ecopelle. Trapuntino imbottito in fibra. Appoggi a terra in alluminio stampato e lucidato oppure nickel nero, con antiscivolo termoplastico neutro. Tutti gli elementi sono completamente svestibili.

**EN** \_The frame, armrests and backrests are in painted steel and guaranteed for 10 years. They are padded in polyurethane foam with varying density and upholstered in a backed acrylic fibre. The seat is in expanded polystyrene with varying density, with memory foam and acrylic fibre, backed with white cotton canvas. The loose cushions of the backrest are filled with goose down in baffle boxes. Small tables in marble, travertine and leather with a plywood frame. Pet's bed: structure in layered rubber, upholstered in eco-leather. Quilt with synthetic filling. Feet in cast aluminium, either polished or in black nickel, with non-slip pads in transparent thermoplastic. The covers of all elements are fully removable.

Tavolini marmo/cuoio/travertino . Small tables in marble/leather/travertine  
Tables de marbre/cuir/travertin . Tischchen aus Marmor/Leder/Travertin

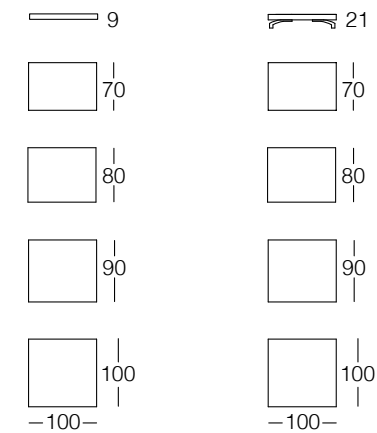

Pet's bed .

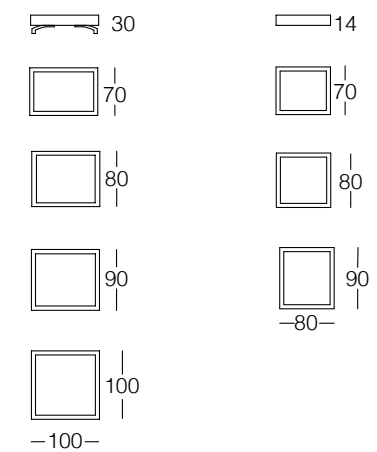

Cuoio . Leather  
Cuir . Leder



Marmo . Marble  
Marbre . Marmor

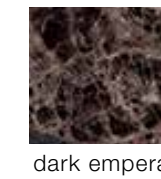

Travertino . Travertine  
Travertin . Travertin



**Composizioni fotografate . Compositions as photographed . Compositions photographiées . Fotografierte Kombinationen**

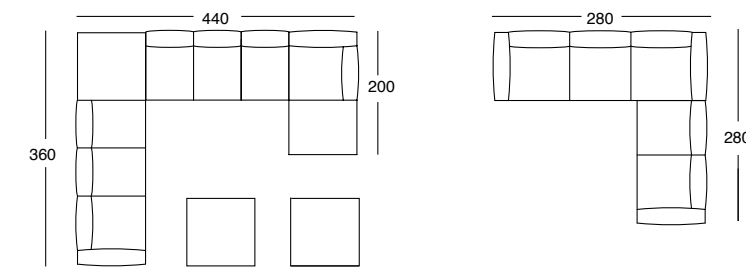

Piedino in alluminio lucidato  
Feet in polished aluminium  
Pied en aluminium poli  
Fuß aus poliertem Aluminium

Piedino in nickel nero  
Feet in black nickel  
Pied en nickel noir  
Füß aus schwarzgefärbtem Nickel

**FR** \_Structure des bases, accoudoirs et dossiers en acier peint garantie 10 ans. Rembourrage en mousse de polyuréthane expansé de différentes densités et recouvert de fibre acrylique. Assise en mousse de polyuréthane expansé de différentes densités avec mousse à mémoire et fibre acrilique enduite avec tissu de coton blanc. Coussins de dossiers en duvet d'oie. Tables de marbre, travertin et cuir avec structure contreplaquée. Lit de compagnie : structure en contreplaqué recouvert de éco-cuir. Doudoune matelassée en fibre. Pieds en aluminium poli ou en nickel noir, avec antidérapant en matériau thermoplastique neutre. Tous les éléments sont entièrement déhoussables.

**DE** \_Unterbauten, Armlehnen und Rückenlehnen aus lackiertem Stahl mit 10 Jahren Garantie. Polsterung aus PU-Schaum mit unterschiedlicher Stärke, Bezug aus kaschierter Acrylfaser. Sitzfläche aus PU-Schaum mit unterschiedlicher Stärke mit Memory Foam und Acrylfaser, bezogen mit weißem Baumwollstoff. Lose Rückenlehnen-Kissen aus kanalisierten Gänsedaunen. Marmor-, Travertin- und Ledertischchen mit Mittellage aus Schichtholz. Pet's bed: Struktur aus gummiertem Schichtholz mit Kunstlederbezug. Steppdecke mit Faserfüllung. Bodenauflagen aus druckgegossenem poliertem Aluminium oder schwarzgefärbtem Nickel mit neutralem thermoplastischem rutschfestem Material. Alle Elemente sind vollkommen abziehbar.

Design  
G. GUALTIEROTTI



**Fly**









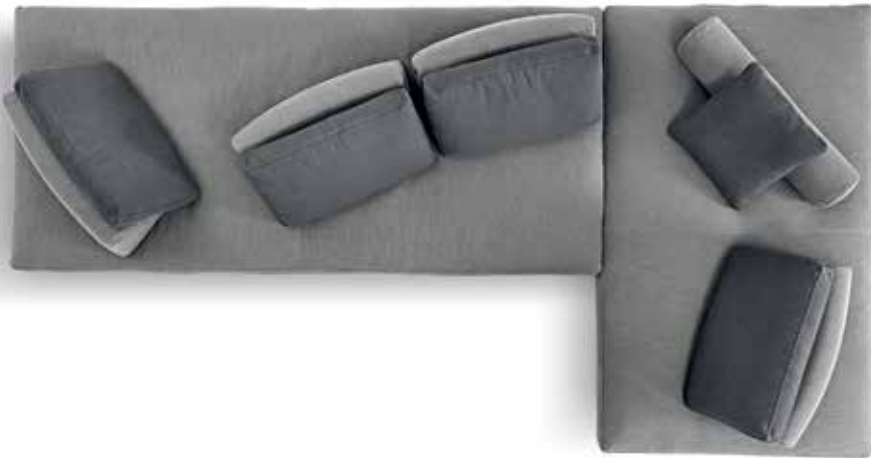











Fly cm. ø 240



Fly cm. ø 240



Fly cm. 240x120



Fly cm. 240x120

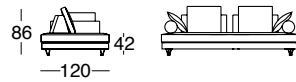

Divani . Sofas  
Canapés . Sofas

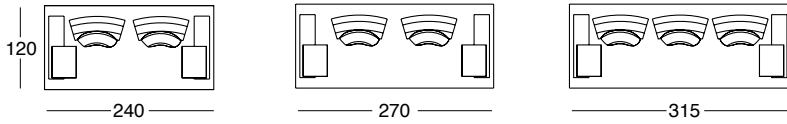

Terminali arco . Curved end units  
Pièces terminales en arc de cercle . Bogen-Abschlusselemente

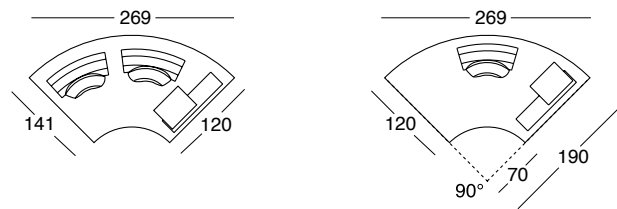

Basi . Base units  
Bases . Unterbauten

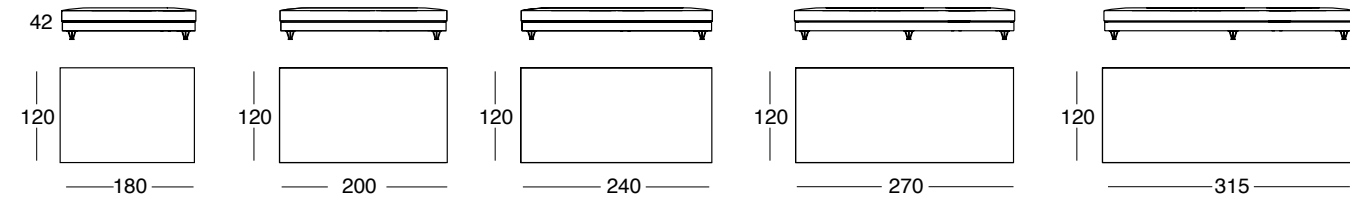

Relax sx-dx . lh-rh chaise longues  
Chaise longue gauche/droite . Chaiselongue links/rechts

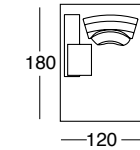

Mezzo tondo . Semicircular  
Demi rond . Halbrundversion

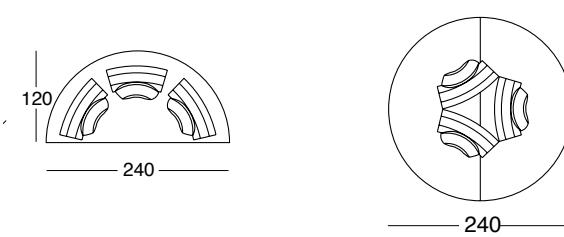

Pouff . Pouf  
Pouf . Polsterelement

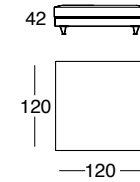

Trapezio . Trapezoid  
Trapèze . Trapezpolster

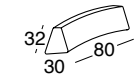

Rullo . Bolster cushion  
Rouleau . Rolle

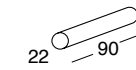

Cuscino schienale . Backrest cushion  
Coussin dossier . Rückenpolster

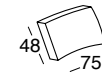

Cuscino bracciolo . Armrest cushion  
Coussin accoudoir . Armpolster

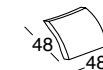

Bracciolo . Armrest  
Accoudoir . Armlehne

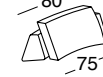
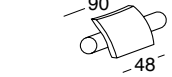

Schienale . Backrest  
Dossier . Rückenlehne

Composizioni fotografate . Compositions as photographed . Compositions photographiées . Fotografierte Kombinationen

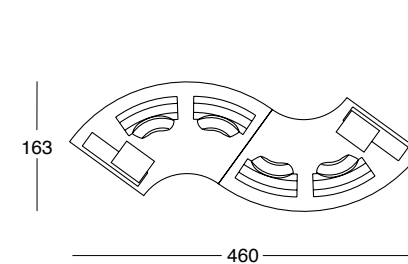

Page 30-31

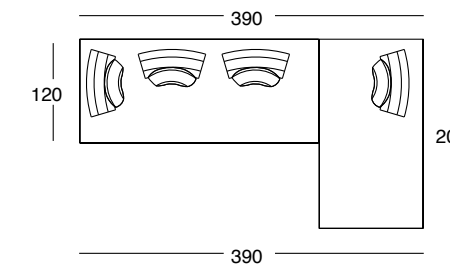

Page 34-35

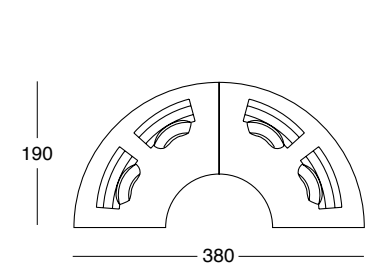

Page 38-39

IT\_Structura interna in acciaio verniciato, garantita 10 anni. Imbottitura in poliuretano espanso a quote differenziate. Sotto rivestimento in fibra acrilica accoppiata. Bracciolo cilindrico, costruito in poliuretano espanso, coperto da soffice falda di piuma. Schienale in poliuretano espanso ricoperto con falda di poliestere. Schienale e bracciolo contengono al proprio interno una serie di sfere nichelate, che consentono agli stessi di rimanere stabili e fissi, in qualsiasi posizione vengano collocati. Cuscini volanti in piuma d'oca canalizzata. Tutti gli elementi sono completamente svestibili.

EN\_Painted steel internal structure, guaranteed for 10 years. Polyurethane foam padding in different densities, upholstered with composite acrylic fibre. The cylindrical armrest is made of polyurethane foam, covered by a soft layer of feathers. The polyurethane foam backrest is covered with a polyester layer. The backrest and armrest have a series of nickel-plated spheres inside to remain stable in any position. Removable cushions in goose down in baffle channels. The covers can be removed from all pieces.

FR\_Structure interne en acier laqué, garantie 10 ans. Garnissage en polyuréthane expansé à cotes différenciées. Dessous, habillage en fibre acrylique double. Accoudoir cylindrique, réalisé en polyuréthane expansé, recouvert d'une ouate douce en duvet. Dossier en polyuréthane expansé recouvert d'ouate de polyester. Le dossier et l'accoudoir contiennent à l'intérieur une série de sphères nickelées, grâce auxquelles ils sont stables et immobiles, quelle que soit leur position. Coussins volants en duvet d'oie cloisonné. Tous les éléments sont entièrement déhoussables.

DE\_Innenkorpus aus lackiertem Metall mit 10 Jahren Garantie. Polsterung aus Schaum-Polyurethan unterschiedlicher Dichte. Unterseits kaschierte Acrylfaserabdeckung. Zylindrische Armlehne aus Schaum-Polyurethan mit weicher Daunenabdeckung. Rückenlehne aus Schaum-Polyurethan mit Polyesterabdeckung. In Rücken- und Armlehne befindet sich eine Reihe von vernickelten Kugeln, mit denen sie in jeder Position stabil und starr bleiben. Lose Kissen aus kanalisiertem Gänsedaunen. Alle Elemente sind vollständig abziehbar.



Design  
G. GUALTIEROTTI

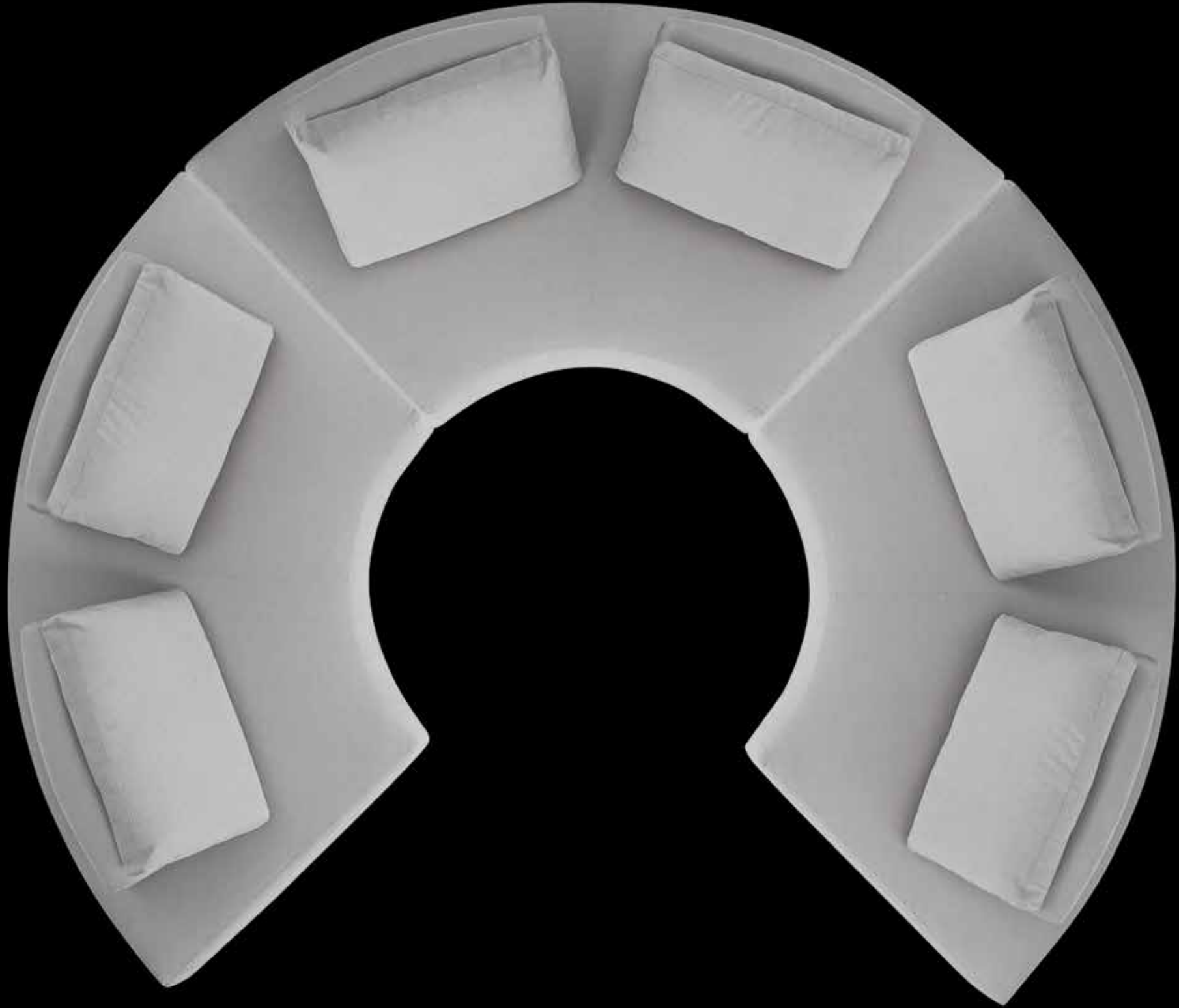

# Fly light















Fly Light cm. 354x177 + Round



Fly Light cm. 180x430

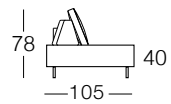

Divani . Sofas  
Canapés . Sofas

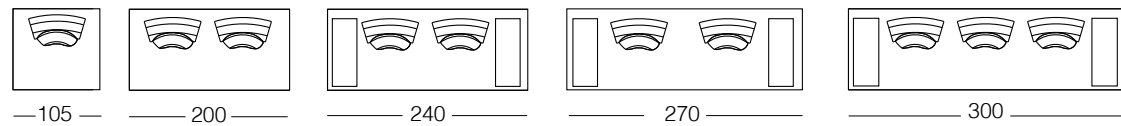

Relax sx-dx . lh-rh chaise longues  
Chaise longue gauche/droite . Chaiselongue links/rechts

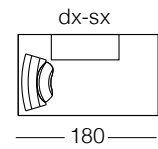

Terminali arco . Curved end units  
Pièces terminales en arc de cercle . Bogen-Abschlusselemente

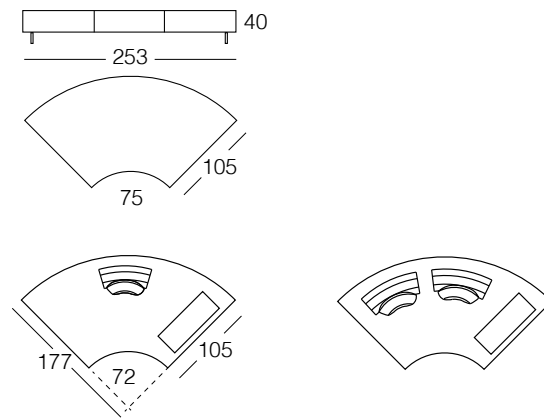

Basi . Base units  
Bases . Unterbauten

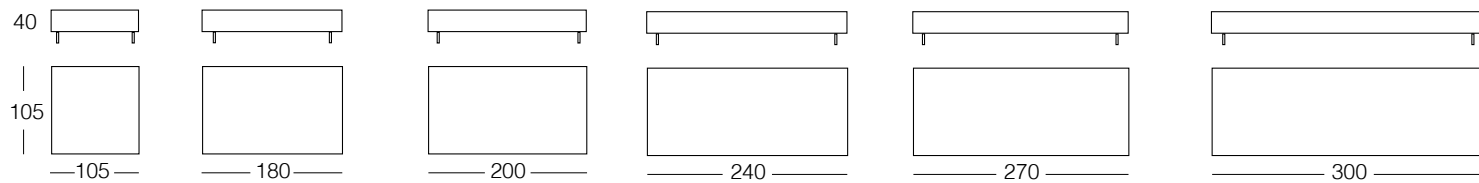

**IT** Struttura interna in metallo verniciato, garantita 10 anni. Imbottitura in poliuretano espanso a quote differenziate, rivestita in fibra acrilica accoppiata. Bracciolo in poliuretano espanso, coperto da trapunta di piuma d'oca garantita. Schienale trapezio in poliuretano espanso con all'interno una serie di sfere nichelate, che consentono agli stessi di rimanere stabili e fissi, in qualsiasi posizione vengano collocati. Cuscino schienale in piuma canalizzata. Piedini in alluminio lucido dotati di antiscivolo in materiale termoplastico neutro. Rivestimento tessuto o pelle. Svestibilità totale. Con l'uso la piattaforma della seduta assumerà un aspetto più morbido e vissuto. Quindi il presentarsi di una leggera ondulazione dell'abito è da considerare assolutamente normale.

**EN** Internal frame in painted metal, guaranteed for 10 years. Padding in expanded polystyrene with varying density. Lower upholstery in backed acrylic fibre. Quilted armrest in expanded polystyrene, with certified goose down filling. Trapezoid backrest in expanded polystyrene, containing a series of nickel-plated spheres which remain stable and in any position they are placed. The back cushion is filled with goose down in baffle boxes. Feet in polished aluminium with non-slip pads in clear thermoplastic. The covers in fabric or leather, are fully removable. Over time, the seating will acquire a softer, more 'lived in' look, which means that a slight ripple effect in the upholstery should be considered totally normal.

Cuscino schienale . Backrest cushion  
Coussin dossier . Rückenpolster

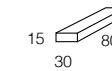

Cuscino bracciolo . Armrest cushion  
Coussin accoudoir . Armpolster

Trapezio . Trapezoid  
Trapèze . Trapezpolster



Cuscino schienale . Backrest cushion  
Coussin dossier . Rückenpolster

Composizioni fotografate . Compositions as photographed . Compositions photographées . Fotografierte Kombinationen

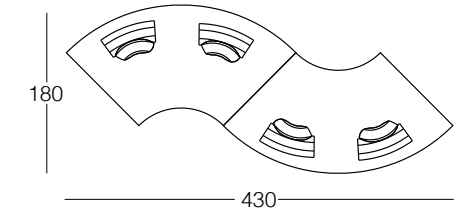
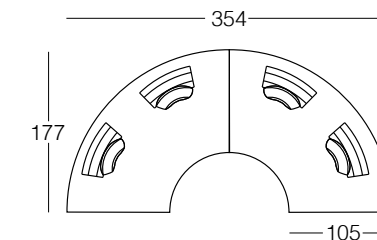
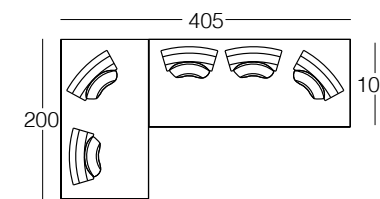

Page 50-51

Page 52-53

Page 55

**FR** Structure interne en métal peint, garantie 10 ans. Rembourrage en mousse de polyuréthane expansé de différentes densités et recouvert de fibre acrylique. Accoudoir en mousse de polyuréthane, couvert de couette en duvet d'oie garanti. Dossier trapèze en mousse de polyuréthane expansé avec à l'intérieur une série de roulements à billes nickelées, qui leur permettent de rester stable et fixe dans n'importe quelle position on le place. Coussins de dossier en plumes canalisées. Pieds en aluminium poli antidérapant en matériaux thermoplastique neutre. Revêtement en tissu ou en cuir. Entièrement déhoussable. Avec l'utilisation la plate-forme de l'assise va assumer un aspect plus doux et vécu. Ainsi, l'apparition d'une légère ondulation du tissu est considérée comme tout à fait normale.

**DE** Interner lackierter Metallrahmen mit 10 Jahren Garantie. Polsterung aus PU-Schaum mit unterschiedlicher Dichte, Bezug aus kaschierter Acrylfaser. Armlehne aus PU-Schaum, bedeckt durch eine Gänsedaunensteppdecke mit Garantie. Die trapezförmige Rückenlehne ist aus PU-Schaum mit einer Reihe vernickelter Kugeln im Innern, wodurch sie in jeder Position, in der sie angeordnet wird, stabil und fest bleibt. Rückenpolster aus kanalisierten Gänsedaunen. Füßchen aus poliertem Aluminium mit neutralem thermoplastischem rutschfestem Material. Bezug aus Stoff oder Leder. Kann vollkommen abgezogen werden. Im Laufe der Verwendung nimmt die Sitzfläche ein weicheres und „eingelebtes“ Aussehen an. Daher ist eine leichte Wellung des Überzugs als absolut normal zu betrachten.



Design  
R. TAPINASSI\_M. MANZONI



**Slim**













Slim cm. 280x280 + Kuadro



Slim cm. 280x280 + Cubic + Deck



Divani . Sofas  
Canapés . Sofas

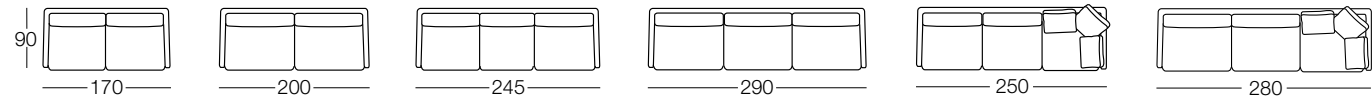

Divani angolari sx-dx . lh-rh corner sofas  
canapés d'angle gauche/droite. Ecksofas links/rechts

Terminali sx-dx . lh-rh end units  
Pièces terminales gauche/droite . Abschlusselemente links/rechts

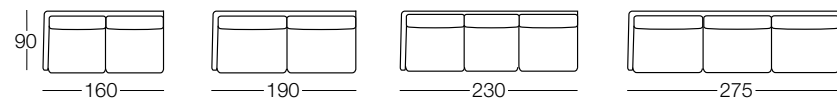

Relax sx-dx . lh-rh chaise longues  
Chaise longue gauche/droite . Chaiselongue links/rechts

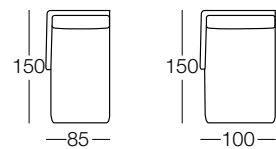

Poltrona . Armchair  
Fauteuil . Sessel

Pouff . Pouf  
Pouf . Polsterelement

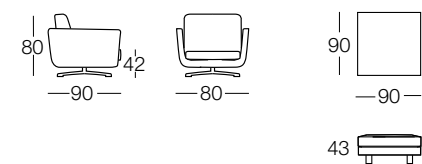

Piedino acciaio cromo  
Base in chrome-plated steel  
Pied en acier chromé  
Füß aus verchromtem Stahl

Piedino acciaio brunito  
Base in burnished steel  
Pied en acier bruni  
Füß aus brüniertem Stahl

Composizioni fotografate . Compositions as photographed . Compositions photographiées . Fotografierte Kombinationen

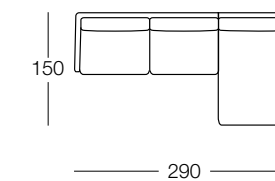

Page 64-65

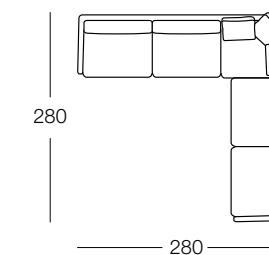

Page 66-67

IT\_Structura in metallo verniciato, garantita 10 anni. Piedini a vista in acciaio cromo o brunito. Imbottitura in poliuretano espanso a quote differenziate, rivestita in fibra acrilica accoppiata. Cuscini seduta e schienale in piuma d'oca con inserto in poliuretano. Tutti gli elementi sono completamente svestibili.

EN\_Structure in painted metal guaranteed for 10 years. Visible feet in chrome-plated or burnished steel. Different density polyurethane foam padding covered in double acrylic fibre. Seat and back cushions in goose down with internal support in polyurethane foam. The covers can be removed from all pieces.

FR\_Structure en métal laqué, garantie 10 ans. Pieds apparents en acier chromé ou bruni. Garnissage en polyuréthane expansé à cotes différenciées recouvert en fibre acrylique double. Les coussins d'assise et dossier sont en duvet d'oie avec avec élément en polyuréthane expansé. Éléments entièrement déhoussables.

DE\_Innenkorpus aus lackiertem Metall mit 10 Jahren Garantie. Sichtbare Füße aus verchromtem oder brüniertem Stahl. Polsterung aus differenziertem PUR-Schaum, Bezug aus kaschierter Acrylfaser. Die Sitzpolster und Rückenlehne sind aus Gänsedaunen mit Einlage aus gepresstem Schaum-Polyurethan. Die Elemente sind vollständig abziehbar.



Design  
G. GUALTIEROTTI



**Veliero**



















Veliero cm. 300



Veliero cm. 300x280





Divani . Sofas  
Canapés . Sofas

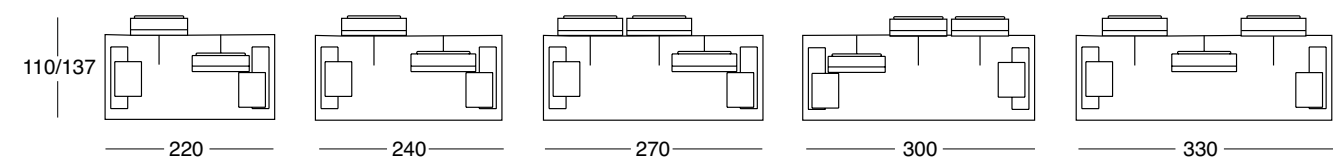

Terminali sx-dx . lh-rh end units  
Pièces terminales gauche/droite . Abschlusselemente links/rechts

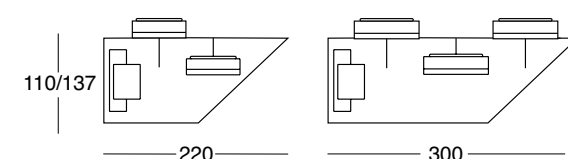
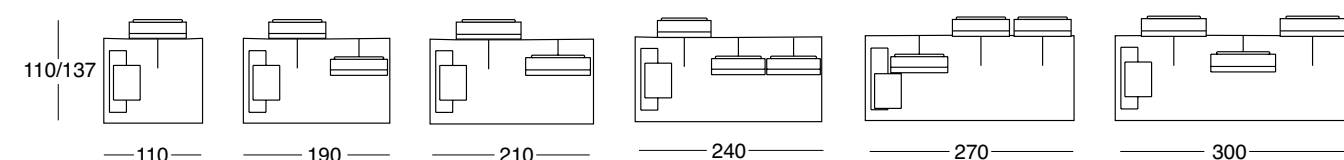

Relax sx-dx . lh-rh chaise longues  
Chaise longue gauche/droite . Chaiselongue links/rechts

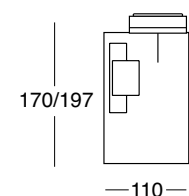

Angolo . Corner unit  
Angle . Eckelement

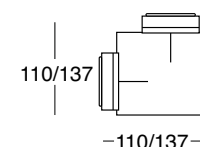

Centrali . Central units  
Éléments centraux . Mittelelemente

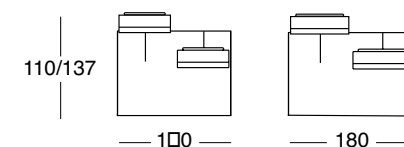

Pouff . Pouf  
Pouf . Polsterelement

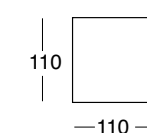

Pouff terminale . End pouf  
Pouf terminal . Abschluss-Polsterelement

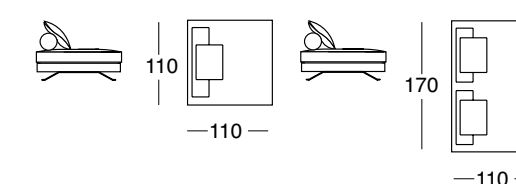

Cuscini . Cushions  
Coussin . Kissen

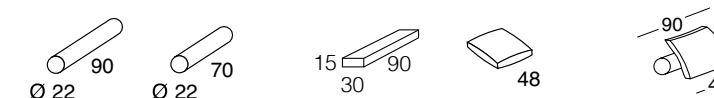

Bracciolo . Armrest  
Accoudoir . Armlehne



Bracciolo cilindrico  
Cylinder-shaped armrest  
Accoudoir cylindrique  
Zylindrische Armlehne



Bracciolo rettangolare  
Rectangular armrest  
Accoudoir rectangulaire  
Rechtwinklige Armlehne

Composizioni fotografate . Compositions as photographed . Compositions photographiées . Fotografierte Kombinationen



Page 74-75

Page 76-77

Page 78-79

Page 80-81

**IT** Collezione di imbottiti con assetto variabile. Un meccanismo brevettato permette di spostare in avanti e/o indietro lo schienale, consentendo un uso diversificato della seduta. Da una posizione relax, con un semplice gesto, si può passare ad una seduta da conversazione. Struttura interna in metallo verniciato, garantita 10 anni. Imbottitura in poliuretano espanso a quote differenziate, rivestita in fibra acrilica accoppiata. Cuscini seduta in piuma d'oca con inserto di poliuretano. Cuscini schienale in piuma d'oca canalizzata. Movimento su leve di acciaio inox. Appoggi a terra in acciaio cromato. Il bracciolo cilindrico, costruito in poliuretano espanso, coperto da una soffice falda di piuma, contiene al suo interno una serie di sfere nichelate che consentono allo stesso di rimanere stabile e fisso in qualunque posizione lo si collochi. Tutti gli elementi sono completamente svestibili.

**EN** Collection of multi-position padded furniture. Thanks to its patented mechanism, the backrest can move forwards and/or backwards so the seat can be used for different purposes. It can go from a lounging to a conversation position with just a simple action. Painted metal internal structure, guaranteed for 10 years. Polyurethane foam padding in different densities, upholstered with composite acrylic fibre. Seat cushions with goose down filling and polyurethane insert. Backrest cushions in goose down in baffled channels. Movement on stainless steel levers. Chrome-plated steel feet. The cylindrical armrest is made of polyurethane foam, covered by a soft layer of feathers, and has a series of nickel-plated spheres inside to remain stable in any position. The covers can be removed from all pieces.

**FR** Collection de canapés rembourrés multi-positions. Un mécanisme breveté permet de déplacer le dossier vers l'avant ou l'arrière, pour utiliser l'assise de différentes manières. Un simple geste suffit pour passer d'une position de détente à une assise pour la conversation. Structure interne en métal laqué, garantie 10 ans. Garnissage en polyuréthane expansé à cotes différenciées, recouvert en fibre acrylique double. Coussins assise en duvet d'oie avec garniture en polyuréthane. Cuscini dossier en duvet d'oie cloisonné. Mouvement sur leviers en acier inox. Appuis au sol en acier chromé. L'accoudoir cylindrique, réalisé en polyuréthane expansé, recouvert d'une ouate moelleuse en duvet, contient à l'intérieur une série de sphères nickelées, grâce auxquelles il est stable et immobile, quelle que soit sa position. Tous les éléments sont entièrement déhoussables.

**DE** Kollektion von Polstermöbeln mit Verstellmöglichkeit. Ein patentierter Mechanismus ermöglicht das Vor- und Zurückklappen der Rückenlehne, um die Sitzfläche auf verschiedene Weise zu nutzen. Aus einer Relax-Position kann man mit einem einfachen Griff in eine Konversationshaltung kommen. Innenkorpus aus lackiertem Metall mit 10 Jahren Garantie. Polsterung aus Schaum-Polyurethan unterschiedlicher Dichte mit kaschierter Acrylfaserabdeckung. Sitzpolster aus Gänsedaunen mit Polyurethan-Einlage. Rückenpolster aus kanalisierten Gänsedaunen. Bewegung mit Edelstahlhebeln. Bodenaufgaben aus verchromtem Stahl. Alle Elemente sind vollständig abziehbar. Im Inneren der zylindrischen Armlehne aus Schaum-Polyurethan mit weicher Daunenabdeckung befindet sich eine Reihe von vernickelten Kugeln, mit denen sie in jeder Position stabil und starr bleibt. Alle Elemente sind vollständig abziehbar.

Design  
G. GUALTIEROTTI



# Le Onde











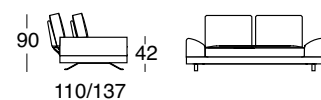

Divani . Sofas  
Canapés . Sofas

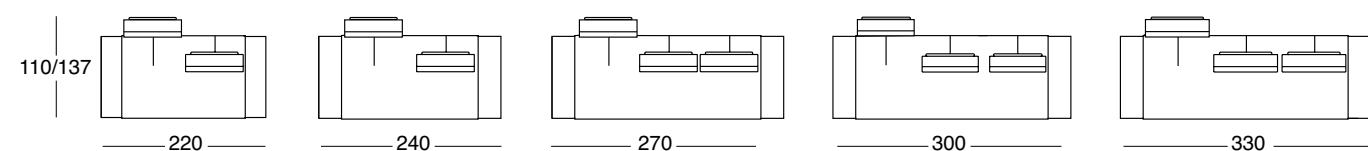

Terminali sx-dx . lh-rh end units  
Pièces terminales gauche/droite . Abschlusselemente links/rechts

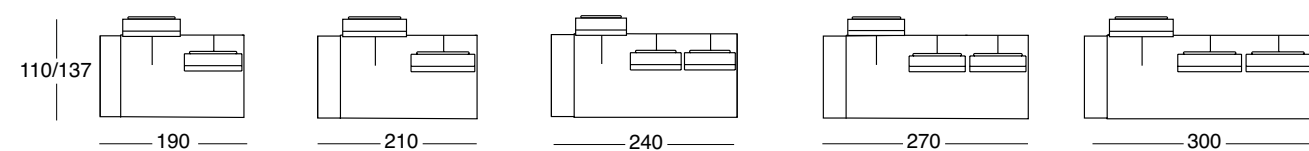

Relax sx-dx . lh-rh chaise longues  
Chaise longue gauche/droite . Chaiselongue links/rechts

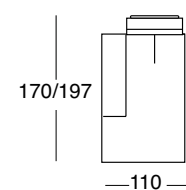

Centrali . Central units  
Éléments centraux . Mittelelemente

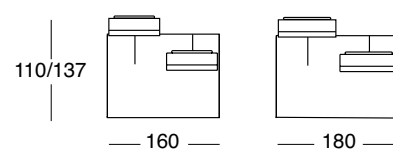

Pouff . Pouf  
Pouf . Polsterelement

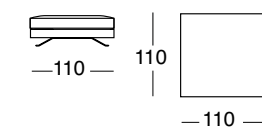

Pouff terminale . End pouf  
Pouf terminal . Abschluss-Polsterelement

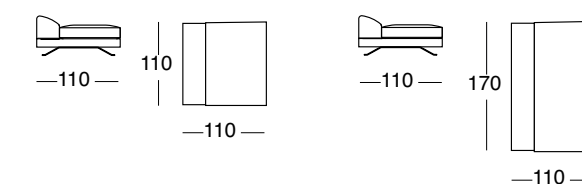

Composizioni fotografate . Compositions as photographed . Compositions photographiées . Fotografierte Kombinationen

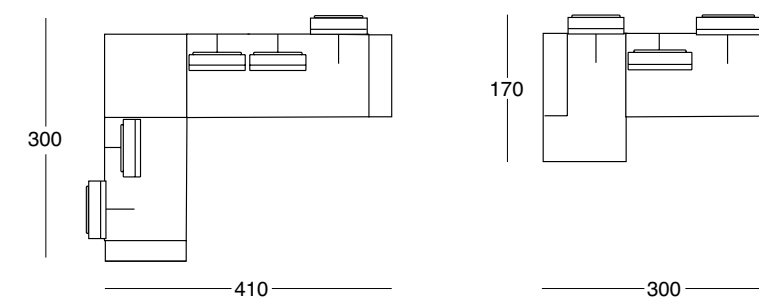

Page 88-89

Page 90-91

**IT** Collezione di imbottiti con assetto variabile. Un meccanismo brevettato permette di spostare in avanti e/o indietro lo schienale, consentendo un uso diversificato della seduta. Da una posizione relax, con un semplice gesto, si può passare ad una seduta da conversazione. Struttura interna in metallo verniciato, garantita 10 anni. Imbottitura in poliuretano espanso a quote differenziate, rivestita in fibra acrilica accoppiata. Cuscini seduta in piuma d'oca con inserto di poliuretano. Cuscini schienale in piuma d'oca canalizzata. Movimento su leve di acciaio inox. Appoggi a terra in acciaio cromato. Tutti gli elementi sono completamente svestibili.

**EN** Collection of multi-position padded furniture. Thanks to its patented mechanism, the backrest can move forwards and/or backwards so the seat can be used for different purposes. It can go from a lounging to a conversation position with just a simple action. Painted metal internal structure, guaranteed for 10 years. Polyurethane foam padding in different densities, upholstered with composite acrylic fibre. Seat cushions with goose down filling and polyurethane insert. Backrest cushions in goose down in baffle channels. Stainless steel levers to adjust position. Chrome-plated steel feet. The covers can be removed from all pieces.

**FR** Collection de canapés rembourrés multi-positions. Un mécanisme breveté permet de déplacer le dossier vers l'avant ou l'arrière, pour utiliser l'assise de différentes manières. Un simple geste suffit pour passer d'une position de détente à une assise pour la conversation. Structure interne en métal laqué, garantie 10 ans. Garnissage en polyuréthane expansé à cotes différenciées, recouvert en fibre acrylique double. Coussins assise en duvet d'oie avec garniture en polyuréthane. Coussins dossier en duvet d'oie cloisonné. Mouvement sur leviers en acier inox. Appuis au sol en acier chromé. Tous les éléments sont entièrement déhoussables.

**DE** Kollektion von Polstermöbeln mit Verstellmöglichkeit. Ein patentierter Mechanismus ermöglicht das Vor- und Zurückklappen der Rückenlehne, um die Sitzfläche auf verschiedene Weise zu nutzen. Aus einer Relax-Position kann man mit einem einfachen Griff in eine Konversationshaltung kommen. Innenkorpus aus lackiertem Metall mit 10 Jahren Garantie. Polsterung aus Schaum-Polyurethan unterschiedlicher Dichte mit kaschierter Acrylfaserabdeckung. Sitzpolster aus Gänsedaunen mit Polyurethan-Einlage Rückenpolster aus kanalisierten Gänsedaunen. Bewegung mit Edelstahlhebeln. Bodenauflagen aus verchromtem Stahl. Alle Elemente sind vollständig abziehbar.



Design  
R. TAPINASSI\_M. MANZONI



**Newport**



















Divani . Sofas  
Canapés . Sofas

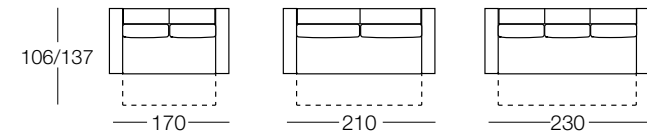

Terminali sx-dx . lh-rh end units  
Pièces terminales gauche/droite . Abschlusselemente links/rechts

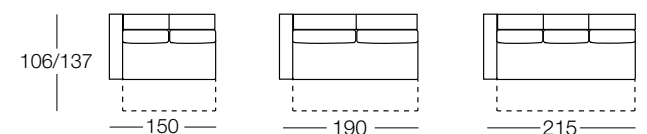

Relax sx-dx . lh-rh chaise longues  
Chaise longue gauche/droite . Chaiselongue links/rechts

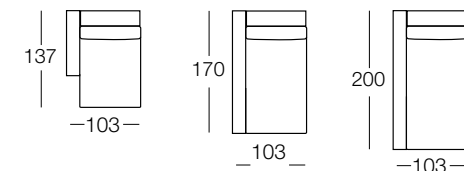

Poltrona . Armchair  
Fauteuil . Sessel

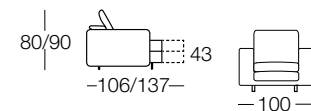

Pouff . Pouf  
Pouf . Polsterelement

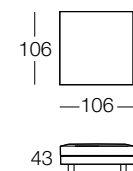

Composizioni fotografate . Compositions as photographed . Compositions photographiées . Fotografierte Kombinationen

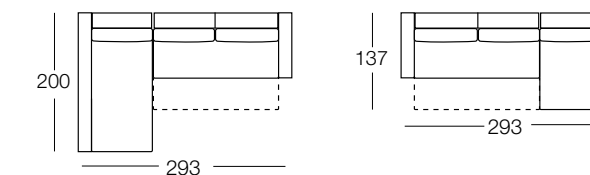

Page 100-101/102-103

Page 104-105

**IT** Tutti gli elementi della collezione possono essere associati a due caratterizzanti meccanismi che ne garantiscono l'assoluta variazione del "sistema comfort". Il primo permette la variazione dell'altezza d'appoggio dei cuscini schienale, ruotando le mensole posteriori in posizione verticale o orizzontale, grazie ad un inedito ed esclusivo meccanismo brevettato. Il secondo interessa la seduta alla quale viene consentito uno scorrimento in avanti aumentando così la profondità utilizzabile e permettendo una completa distensione del corpo. Le strutture sono in metallo e garantite 10 anni. I piedini sono in acciaio satinato. Le imbottiture della seduta sono in poliuretano espanso a densità differenziata, con trapunta in piuma, e i cuscini dello schienale in piuma d'oca canalizzata. Tutti gli elementi sono completamente svestibili.

**EN** All pieces in the collection may be associated with two special mechanisms that guarantee an absolute variation of the "comfort system". The first allows height variation of the back cushions via rotation of the rear brackets to a vertical or horizontal position, thanks to an innovative, exclusive patented mechanism. The second involves the seat, which may be slid forwards, thus increasing the usable depth and letting the body stretch out completely. All the structures are in metal and guaranteed for 10 years. Satin finish steel feet. Seat padding in polyurethane foam in different densities with quilted layer of goose down, back cushions in goose down in baffle channels. The covers can be removed from all pieces.

**FR** Tous les éléments de la collection peuvent être associés à deux mécanismes spéciaux qui garantissent une variation absolue du « système confort ». Le premier permet de varier la hauteur d'appui des coussins dossier, en faisant pivoter les tablettes arrière en position verticale ou horizontale, grâce à un mécanisme breveté inédit et exclusif. Le deuxième concerne l'assise, qui peut coulisser vers l'avant pour augmenter ainsi la profondeur utilisable et permettre de s'allonger complètement. Les structures en métal sont garanties 10 ans. Pieds en acier satiné. Les garnissages d'assise sont en polyuréthane expansé à densité différenciée avec un matelassage en plum, les coussins de dossier en duvet d'oie canalisé. Tous les éléments sont entièrement déhoussables.

**DE** Alle Elemente der Kollektion können mit zwei charakteristischen Mechanismen ausgestattet werden, die eine absolute Flexibilität des "Komfortsystems" ermöglichen. Der erste, ein neuartiger, exklusiver, patentierter Mechanismus, ermöglicht die Höhenverstellung der Rückenpolster durch Drehen der hinteren Konsolen in senkrechte oder waagerechte Position. Der zweite wirkt auf die Sitzfläche, die nach vorn gleiten kann, womit die nutzbare Tiefe vergrößert und ein vollständiges Ausstrecken des Körpers ermöglicht wird. Die Korpusse sind aus Metall mit 10 Jahren Garantie. Die Füße sind aus satiniertem Stahl. Die Sitzpolster sind aus Schaum-Polyurethan unterschiedlicher Dichte mit einer gesteppten Abdeckung aus Gänsedaunen und die Rückenpolster aus kanalisierten Gänsedaunen. Alle Elemente sind vollständig abziehbar.

Design  
R. TAPINASSI\_M. MANZONI



**Boss**

















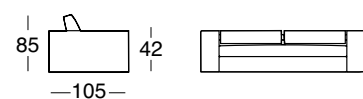

Divani . Sofas  
Canapés . Sofas

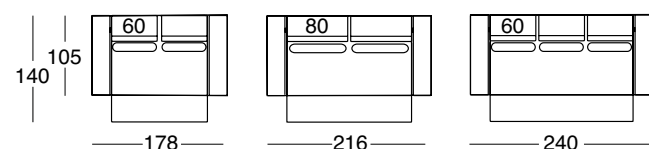

Terminali sx-dx . lh-rh end units  
Pièces terminales gauche/droite . Abschlusselemente links/rechts

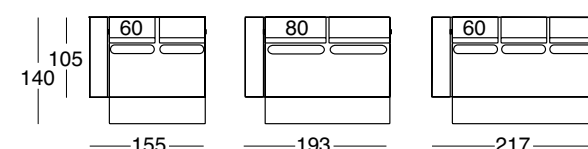

Relax sx-dx con meccanismo . Chaise longue with left-right mechanism  
Chaise longue gauche/droite avec mécanisme . Chaiselongue links/rechts mit Mechanismus

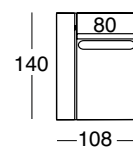

Relax sx-dx . lh-rh chaise longues  
Chaise longue gauche/droite . Chaiselongue links/rechts

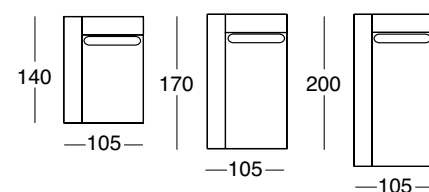

Centrale . Central units  
Élément central . Mittelelement

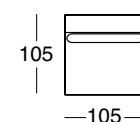

Angolo . Corner unit  
Angle . Eckelement

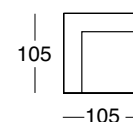

Pouff . Pouf  
Pouf . Polsterelement

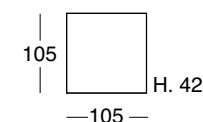

Cuscini spalliera . Backrest cushions  
Coussins dossier . Rückenpolster

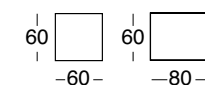

#### Composizioni fotografate . Compositions as photographed . Compositions photographiées . Fotografierte Kombinationen

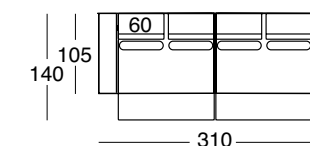

Page 112-113/114-115

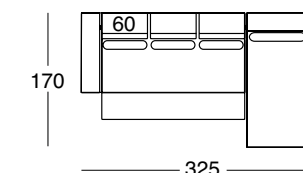

Page 116-117

**IT** Tutti gli elementi della collezione possono essere associati a due caratterizzanti meccanismi che ne garantiscono l'assoluta variazione del "sistema comfort". Il primo permette la variazione dell'altezza d'appoggio dei cuscini schienale, ruotando le mensole posteriori in posizione verticale o orizzontale, grazie ad un inedito ed esclusivo meccanismo brevettato. Il secondo interessa la seduta alla quale viene consentito uno scorrimento in avanti aumentando così la profondità utilizzabile e permettendo una completa distensione del corpo. Le strutture sono in metallo e garantite 10 anni. Le imbottiture sono in poliuretano espanso a densità differenziata e i cuscini in piuma d'oca canalizzata. Tutti gli elementi sono completamente svestibili.

**EN** All pieces in the collection may be associated with two special mechanisms that guarantee an absolute variation of the "comfort system". The first allows height variation of the back cushions via rotation of the rear brackets to a vertical or horizontal position, thanks to an innovative, exclusive patented mechanism. The second involves the seat, which may be slid forwards, thus increasing the usable depth and letting the body stretch out completely. All the structures are in metal and guaranteed for 10 years. Polyurethane foam padding in different densities and cushions in goose down in baffle channels. The covers can be removed from all pieces.

**FR** Tous les éléments de la collection peuvent être associés à deux mécanismes spéciaux qui garantissent une variation absolue du « système confort ». Le premier permet de varier la hauteur d'appui des coussins dossier, en faisant pivoter les tablettes arrière en position verticale ou horizontale, grâce à un mécanisme breveté inédit et exclusif. Le deuxième concerne l'assise, qui peut coulisser vers l'avant pour augmenter ainsi la profondeur utilisable et permettre de s'allonger complètement. Les structures en métal sont garanties 10 ans. Les garnissages sont en polyuréthane expansé à densité différenciée et les coussins en duvet d'oie canalisé. Tous les éléments sont entièrement déhoussables.

**DE** Alle Elemente der Kollektion können mit zwei charakteristischen Mechanismen ausgestattet werden, die eine absolute Flexibilität des "Komfortsystems" ermöglichen. Der erste, ein neuartiger, exklusiver, patentierter Mechanismus, ermöglicht die Höhenverstellung der Rückenpolster durch Drehen der hinteren Konsolen in senkrechte oder waagerechte Position. Der zweite wirkt auf die Sitzfläche, die nach vorn gleiten kann, womit die nutzbare Tiefe vergrößert und ein vollständiges Ausstrecken des Körpers ermöglicht wird. Die Korpusse sind aus Metall mit 10 Jahren Garantie. Die Polsterungen sind aus Schaum-Polyurethan unterschiedlicher Dichte und die Kissen aus kanalisiertem Gänsedaunen. Alle Elemente sind vollständig abziehbar.

Design  
M. LIPPARINI



**Babiloniadue**

















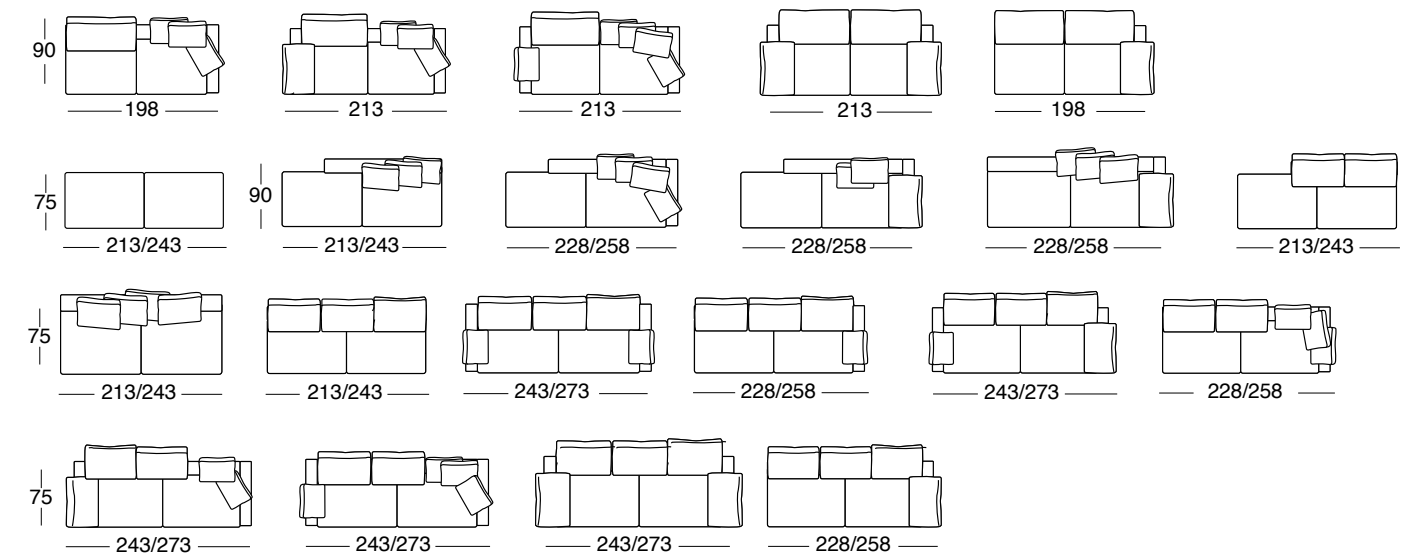
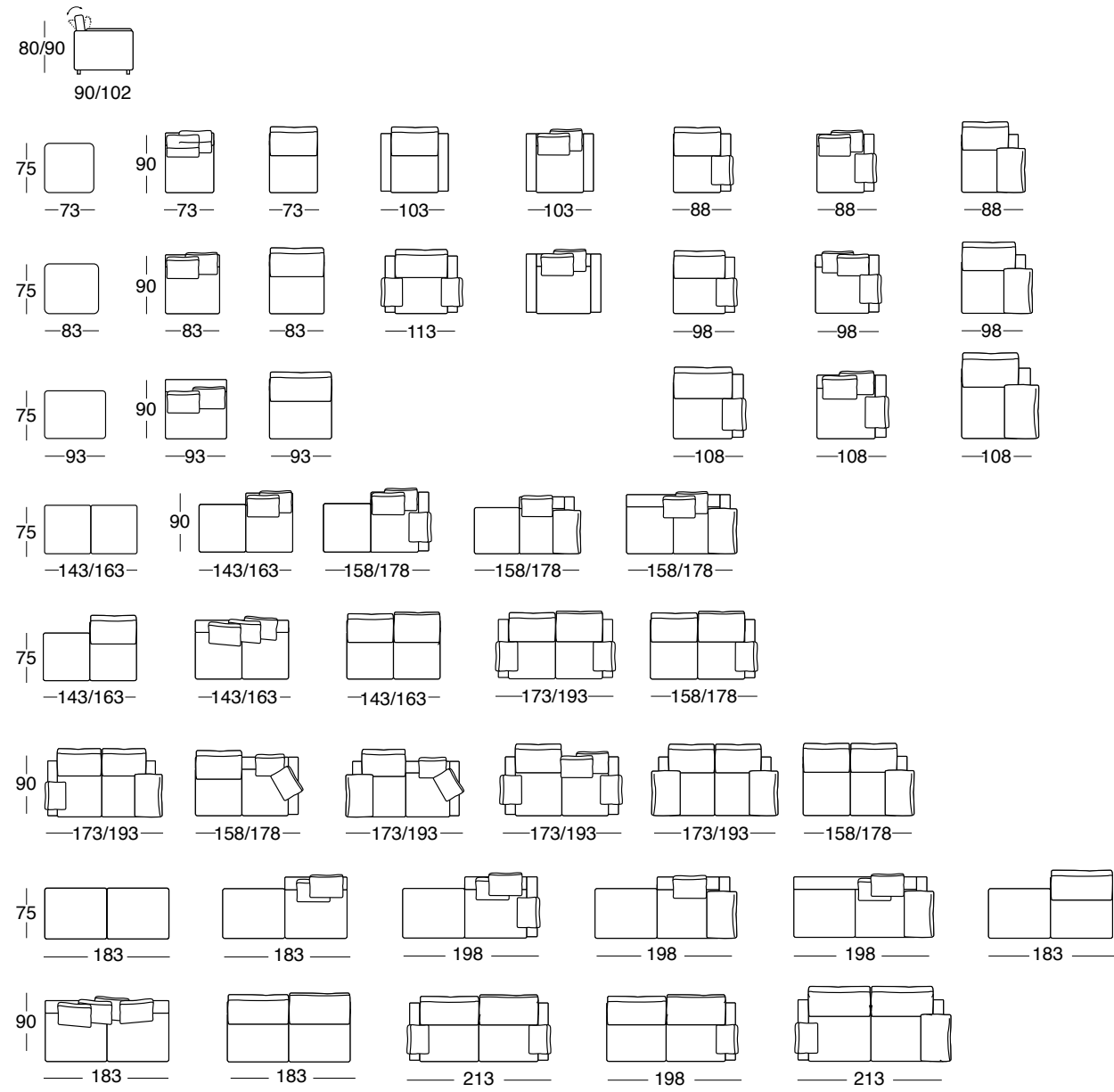

Cuscino . Cushion . Coussin . Kissen

Angolo . Corner unit . Angle . Eckelement

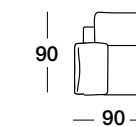
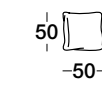

Composizioni fotografate . Compositions as photographed . Compositions photographiées . Fotografierte Kombinationen

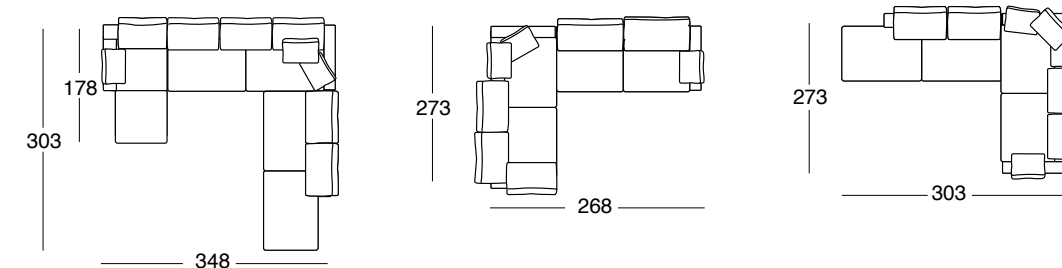

Page 124-125

Page 126-127

Page 128-129

**IT** Struttura portante in acciaio e parti perimetrali in legno imbottite in schiuma poliuretanic a quote differenziate e rivestite con tessuto protettivo accoppiato. Cuscini seduta in poliuretano espanso a quote differenziate e fibra poliestere termolegata, rivestiti con tela di cotone bianca. Cuscini schienale in piuma d'oca certificata e garantita rivestita con tela di cotone antipiuma di colore naturale e con inserto interno in poliuretano schiumato a stampo predisposto per l'alloggio del meccanismo. Il movimento del cuscino schienale avviene tramite due snodi in nylon, frizionati, indipendenti tra di loro e con garanzia assoluta di funzionalità nel tempo; progetto e brevetto Dema. I cuscini volanti sono in piuma d'oca certificata e garantita. I piedi hanno sezione quadrata e sono realizzati in alluminio spazzolato, completi di antiscivolo in materiale termoplastico neutro. Rivestimento in tessuto o pelle. Svestibilità completa.

Note: - Con il cuscino schienale completamente arretrato la profondità di Babiloniadue aumenta di circa 12 cm. e l'altezza diminuisce di circa 10 cm. Con l'uso la piattaforma della seduta assumerà un aspetto più morbido e vissuto. Quindi il presentarsi di una leggera ondulazione dell'abito, sia in tessuto che in pelle, è da considerarsi assolutamente normale.

**EN** Steel frame with edges in wood, padded in differentiated density of polyurethane foam and upholstered with matching protective fabric. Seat cushions in differentiated density of polyurethane foam and heat-bonded polyester fibre, covered white cotton fabric. Back cushions in certified and guaranteed goose down, covered with natural coloured feather-proof cotton. The sofa back is moved by means of two nylon smoothly working joints, independent between them, with absolute guarantee of functionality throughout time; designed and patented by Dema. The loose cushions are in certified and guaranteed goose down. Stands are square and made in brushed aluminum, equipped with neutral thermoplastic anti-slip material. Upholstered in fabric or leather. With fully removable covers.

Note: - When the sofa back is fully reclined, the depth of Babiloniadue increases by approximately 12 cms, and the height decreases by approximately 10 cms. - With use the seating will become softer and more "lived-in"; therefore a slight wrinkling of the covering is perfectly normal.

**FR** Structure portante en acier et pourtour en bois garni de mousse polyuréthane à cotes différenciées et recouvert de tissu de protection double. Coussins assise en polyuréthane expansé à cotes différenciées et fibre polyester liée à chaud, recouverts d'une toile de coton blanche. Coussins dossier en duvet d'oie certifié et garanti recouvert d'une toile de coton anti-plume de couleur naturelle et élément intérieur en mousse de polyuréthane moulé, prévu pour loger le mécanisme. Le mouvement du coussin dossier est possible grâce à deux rotules en nylon, avec frictionnage, indépendantes l'une de l'autre et avec une garantie absolue de fonctionnalité dans le temps ; projet et brevet Dema. Les coussins volants sont en duvet d'oie certifié et garanti. Les pieds ont une section carrée. Ils sont réalisés en aluminium brossé et comprennent une partie antidérapante en matériau thermoplastique neutre. Habillage en tissu ou en cuir. Entièrement déhoussable.

Notes : - Avec le coussin dossier en position entièrement reculée, la profondeur de Babiloniadue augmente d'environ 12 cm, alors que la hauteur diminue d'environ 10 cm. - Avec l'usage, l'assise prendra un aspect plus souple et vieilli ; une légère ondulation de l'habillage, en tissu ou en cuir, est donc tout à fait normale.

**DE** Korpus aus Stahl und Außenteile aus Holz mit Polsterung aus Schaum-Polyurethan unterschiedlicher Dichte mit kaschiertem Schutzbezug aus Stoff. Sitzpolster aus Schaum-Polyurethan unterschiedlicher Dichte und heiß geklebter Polyesterfaser, bezogen mit weißem Baumwollstoff. Rückenpolster aus zertifizierten und garantierten Gänsedaunen, bezogen mit naturfarbenem, daunendichtem Baumwollstoff mit Einlage aus gepresstem Schaum-Polyurethan zum Einsetzen des Mechanismus. Die Bewegung des Rückenpolsters erfolgt mit zwei voneinander unabhängigen Gelenken aus Nylon mit Rutschkupplung und mit absoluter langfristiger Funktionsgarantie; Entwicklung und Patent von Dema. Die losen Kissen sind aus zertifizierten und garantierten Gänsedaunen. Die Füße haben quadratischen Querschnitt und sind aus gebürstetem Aluminium mit Rutschsicherung aus neutralem thermoplastischem Material. Bezug aus Stoff oder Leder. Vollständig abziehbar.

Anmerkungen: - Bei ganz nach hinten geschobenem Rückenpolster erhöht sich die Sitztiefe des Babiloniadue um rund 12 cm und die Höhe verringert sich um rund 10 cm. - Mit dem Gebrauch nimmt die Plattform der Sitzfläche ein weiches, lockereres Aussehen an, daher ist das Auftreten einer leichten Wellung des Stoff- oder Lederbezugs als völlig normal anzusehen.

Design  
R. TAPINASSI\_M. MANZONI



**Modulor**















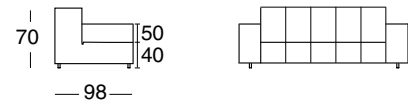

Divani . Sofas  
Canapés . Sofas

Centrali . Central units  
Éléments centraux . Mittelelemente

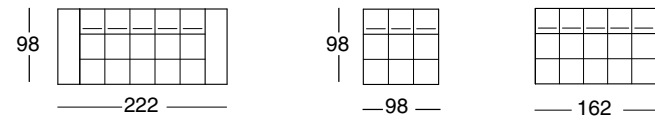

Terminali sx-dx . lh-rh end units  
Pièces terminales gauche/droite . Abschlusselemente links/rechts

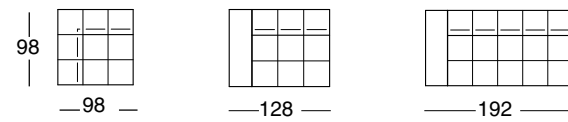

Angolo . Corner unit  
Angle . Eckelement

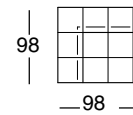

Pouff . Pouf  
Pouf . Polsterelement

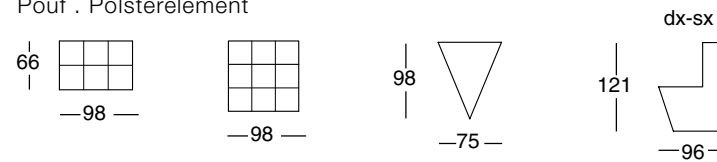

**IT** La struttura è in acciaio, imbottita in schiuma poliuretana a quote differenziate e rivestita con tessuto protettivo accoppiato. Le sedute e gli schienali sono integrati nella struttura e sono realizzati a stampo in poliuretano espanso a quote differenziate e fibra termolegata, rivestiti in tela di cotone bianco. Piedi: in metallo verniciato con polveri epossidiche di colore cromo metallizzato e completi di antiscivoli in materiale termoplastico neutro. Rivestimento: in tessuto o pelle. Svestibilità: totale.

**EN** Steel structure, padded with different densities of polyurethane foam and covered with a matching protective fabric. Seat and back cushions are integrated in the structure and made of differentiated densities of moulded polyurethane foam and heat-bonded fibre, covered with white cotton fabric. Feet: chromed epoxy powders lacquered metal; complete with neutral thermoplastic non-slip end elements. Upholstery: fabric or leather. With fully removable cover.

Composizioni fotografate . Compositions as photographed . Compositions photographiées . Fotografierte Kombinationen

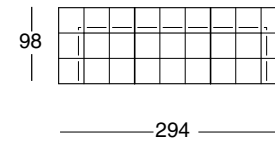

Page 134-135

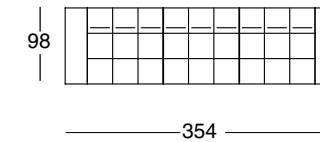

Page 136-137

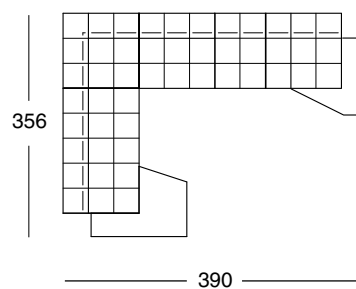

Page 138-139

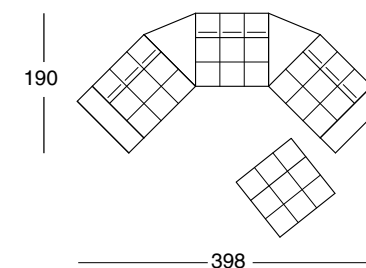

Page 140-141

**FR** La structure est en acier, garnie en mousse polyuréthane à cotes différenciées et recouverte en tissu de protection double. Les assises et les dossiers sont intégrés dans la structure. Moulés en polyuréthane expansé à cotes différenciées et fibre liée à chaud, ils sont recouverts d'une toile de coton blanc. Pieds : en métal laqué aux poudres époxy de couleur chrome métallisé et avec des éléments antidérapants en matériau thermoplastique neutre. Habillage : en tissu ou en cuir. Déhoussable : entièrement.

**DE** Der Korpus ist aus Stahl mit Polsterung aus Schaum-Polyurethan unterschiedlicher Dichte mit kaschierter Schutzbezug aus Stoff. Die Sitzflächen und Rückenlehnen sind in den Korpus eingebaut und aus gepresstem Schaum-Polyurethan unterschiedlicher Dichte und heiß geklebter Polyesterfaser, bezogen mit weißem Baumwollstoff. Füße: aus metallisch-chromfarbenem epoxy-lackiertem Metall mit Rutschsicherung aus neutralem thermoplastischem Material. Bezug: aus Stoff oder Leder. Abziehbarkeit: komplett.

Design  
C. BIMBI



**Rialto**











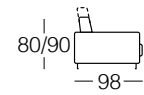

Divani . Sofas  
Canapés . Sofas

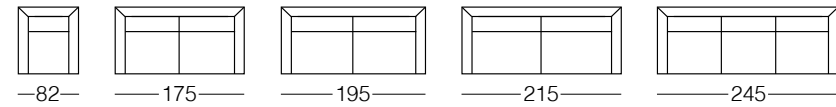

Terminali sx-dx . lh-rh end units  
Pièces terminales gauche/droite . Abschlusselemente links/rechts

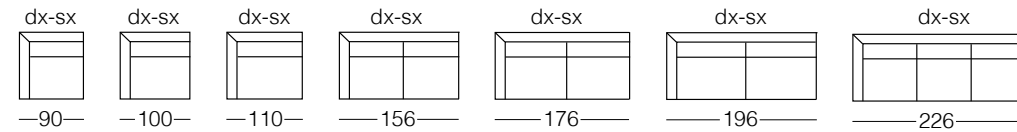

Angolo . Corner unit  
Angle . Eckelement

Relax sx-dx . lh-rh chaise longues  
Chaise longue gauche/droite . Chaiselongue links/rechts

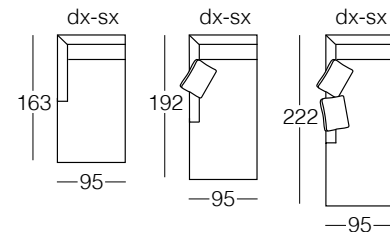
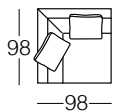

Pouff . Pouf  
Pouf . Polsterelement

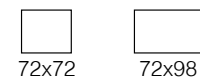

Composizioni fotografate . Compositions as photographed . Compositions photographiées . Fotografierte Kombinationen

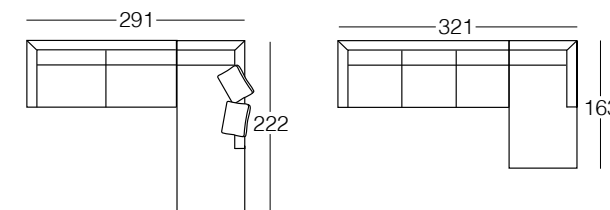

Page 150-151

Page 150-151

**IT** Struttura in acciaio e molleggio in acciaio armonico garantiti 10 anni. Imbottitura in poliuretano espanso a quote differenziate, rivestita in fibra acrilica accoppiata. Cuscini seduta e schienale in poliuretano espanso a quote differenziate rivestiti in falda acrilica con foderina in cotone. Elementi completamente svestibili. Dotato di uno speciale meccanismo che permette il sollevamento manuale del cuscino schienale anche restando seduti. Piedini in acciaio satinato completi di antiscivolo in materiale termoplastico neutro.

**FR** Structure en acier et suspension en acier harmonique garanties 10 ans. Garnissage en polyuréthane expansé à cotes différenciées, recouvert en fibre acrylique double. Les coussins d'assise et dossier sont en polyuréthane expansé à cotes différenciées, recouverts en ouate acrylique avec housse en coton. Éléments entièrement déhoussables. Simple mécanisme permettant de soulever manuellement le coussin du dossier sans se lever. Pieds en acier brossé complets avec antidérapant en matériau thermoplastique neutre.

**EN** Steel structure with springs in music wire steel, guaranteed for 10 years. Polyurethane foam padding in different densities, upholstered with composite acrylic fibre. The seat cushions and backrest are in polyurethane foam in different densities, upholstered with acrylic fibre layer and a fine cotton cover. The covers can be removed from all pieces. Equipped with a special mechanism that makes it possible to manually raise the back cushion when seated. Feet in satin-finished steel with non-slip pads in clear thermoplastic.

**DE** Stahlkorpus und Federung aus Federstahl mit 10 Jahren Garantie. Polsterung aus Schaum-Polyurethan unterschiedlicher Dichte mit kaschierter Acrylfaserabdeckung. Die Sitzpolster und Rückenlehne sind aus Schaum-Polyurethan unterschiedlicher Dichte mit Acrylflaserabdeckung mit Kaschierfutter. Die Elemente sind vollständig abziehbar. Mit einem Spezialmechanismus, der das manuelle Höherstellen des Rückenpolsters auch im Sitzen ermöglicht. Füße aus satiniertem Stahl mit neutralem thermoplastischem rutschfestem Material.



Design  
C. BIMBI



**Altobasso  
plus**







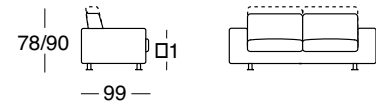

Divani . Sofas  
Canapés . Sofas

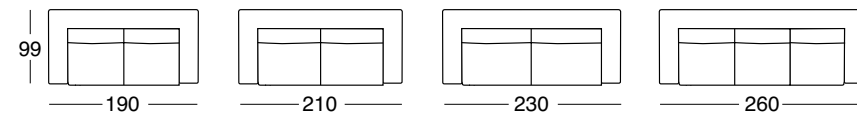

Terminali sx-dx . lh-rh end units  
Pièces terminales gauche/droite . Abschlusselemente links/rechts

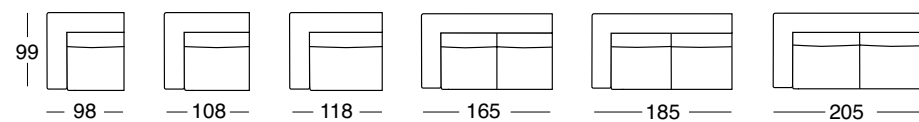

Relax sx-dx . lh-rh chaise longues  
Chaise longue gauche/droite . Chaiselongue links/rechts

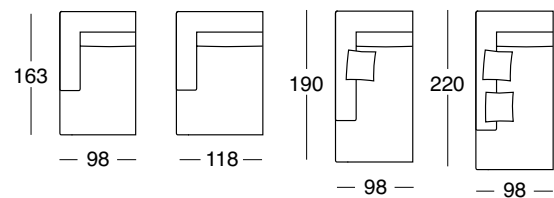

Angolo . Corner unit  
Angle . Eckelement

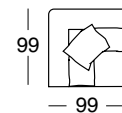

Pouff . Pouf  
Pouf . Polsterelement

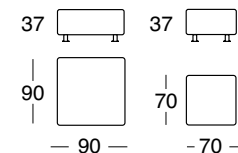

Cuscino . Cushion  
Coussin . Kissen



Poltrona . Armchair  
Fauteuil . Sessel

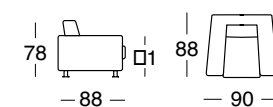

Composizioni fotografate . Compositions as photographed . Compositions photographiées . Fotografierte Kombinationen

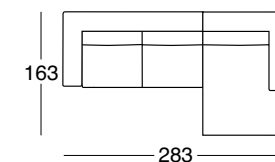

Page 158-159

**IT** Struttura in acciaio e molleggio in acciaio armonico garantiti 10 anni. Imbottitura in poliuretano espanso a quote differenziate, rivestita in fibra acrilica accoppiata. Cuscini seduta e schienale in poliuretano espanso a quote differenziate rivestiti in falda acrilica con foderina in cotone. Elementi completamente svestibili. Dotato di uno speciale meccanismo che permette il sollevamento manuale del cuscino schienale anche restando seduti. Piedini quadrati in alluminio spazzolato e verniciato, completi di antiscivolo in materiale termoplastico neutro.

**EN** Steel structure with springs in music wire steel, guaranteed for 10 years. Polyurethane foam padding in different densities, upholstered with composite acrylic fibre. The seat cushions and backrest are in polyurethane foam in different densities, upholstered with acrylic fibre layer and a fine cotton cover. The covers can be removed from all pieces. Equipped with a special mechanism that makes it possible to manually raise the back cushion when seated. Square shaped feet in brushed, painted aluminium with non-slip pads in clear thermoplastic.

**FR** Structure en acier et suspension en acier harmonique garanties 10 ans. Garnissage en polyuréthane expansé à cotes différenciées, recouvert en fibre acrylique double. Les coussins d'assise et dossier sont en polyuréthane expansé à cotes différenciées, recouverts en ouate acrylique avec housse en coton. Éléments entièrement déhoussables. Simple mécanisme permettant de soulever manuellement le coussin du dossier sans se lever. Pieds carrés en aluminium brossé et peint, complets avec antidérapant en matériau thermoplastique neutre.

**DE** Stahlkorpus und Federung aus Federstahl mit 10 Jahren Garantie. Polsterung aus Schaum-Polyurethan unterschiedlicher Dichte mit kaschierter Acrylfaserabdeckung. Die Sitzpolster und Rückenlehne sind aus Schaum-Polyurethan unterschiedlicher Dichte mit Acrylvliesabdeckung mit Kaschierfutter. Die Elemente sind vollständig abziehbar. Mit einem Spezialmechanismus, der das manuelle Höherstellen des Rückenpolsters auch im Sitzen ermöglicht. Quadratische FüÙe aus gebürstetem und lackiertem Aluminium, mit neutralem thermoplastischem rutschfestem Material.



Design  
C. BIMBI



**Dynamic  
plus**













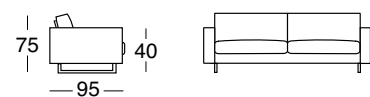

Divani . Sofas  
Canapés . Sofas

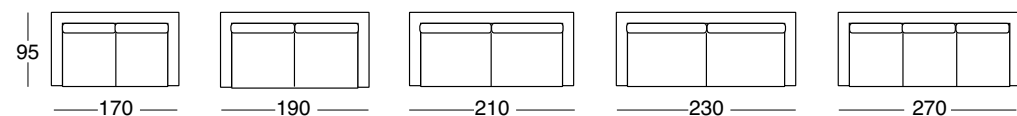

Terminali sx-dx . lh-rh end units  
Pièces terminales gauche/droite . Abschlusselemente links/rechts

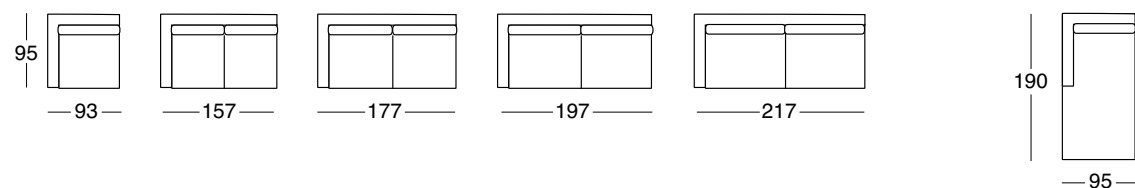

Relax sx-dx . lh-rh chaise longues  
Chaise longue gauche/droite . Chaiselongue links/rechts

Angolo sx-dx . lh-rh Corner unit  
Angle gauche/droite . Eckelement links/rechts

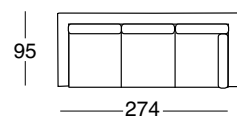
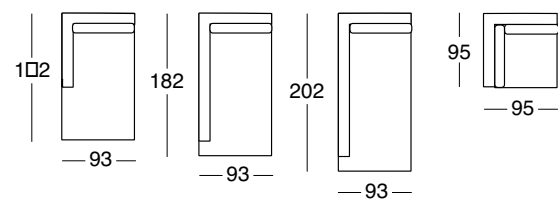

Poltrona . Armchair  
Fauteuil . Sessel

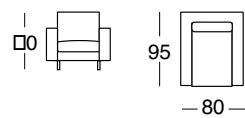

Composizioni fotografate . Compositions as photographed . Compositions photographiées . Fotografierte Kombinationen

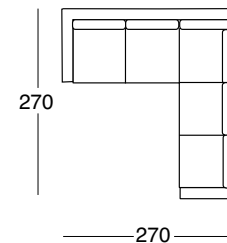
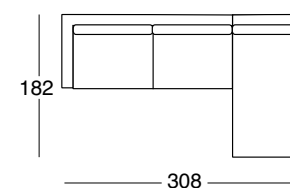

Page 166-167

Page 168-169

IT\_Structura in acciaio e molleggio in acciaio armonico garantiti 10 anni. Imbottitura in poliuretano espanso a quote differenziate, rivestita in fibra acrilica accoppiata. I cuscini di seduta sono in poliuretano espanso a quote differenziate, rivestiti in falda acrilica con foderina in cotone e gli schienali in resinpiuma. Elementi completamente svestibili. Piedini e supporto schienali a vista in acciaio inox satinato.

FR\_Structure en acier et suspension en acier harmonique garanties 10 ans. Garnissage en polyuréthane expansé à cotes différenciées, recouvert en fibre acrylique double. Les coussins d'assise sont en polyuréthane expansé à cotes différenciées, recouverts en ouate acrylique avec housse en coton et les dossiers sont en Resinpiuma. Éléments entièrement déhoussables. Pieds et support dossiers apparents en acier inox satiné.

EN\_Steel structure with springs in music wire steel, guaranteed for 10 years. Polyurethane foam padding in different densities, upholstered with composite acrylic fibre. The seat cushions are in polyurethane foam in different densities, upholstered with acrylic fibre layer and a fine cotton cover, while the backs are in Resinpiuma. The covers can be removed from all pieces. Visible feet and back support in satin stainless steel.

DE\_Stahlkorpus und Federung aus Federstahl mit 10 Jahren Garantie. Polsterung aus Schaum-Polyurethan unterschiedlicher Dichte mit kaschierter Acrylfaserabdeckung. Die Sitzpolster sind aus Schaum-Polyurethan unterschiedlicher Dichte mit Acrylvliesabdeckung mit Kaschierfutter und die Rückenlehnen aus Resinpiuma. Die Elemente sind vollständig abziehbar. Sichtbare Füße und Rückenstützen aus satiniertem Edelstahl.

Design  
R. SPENCER

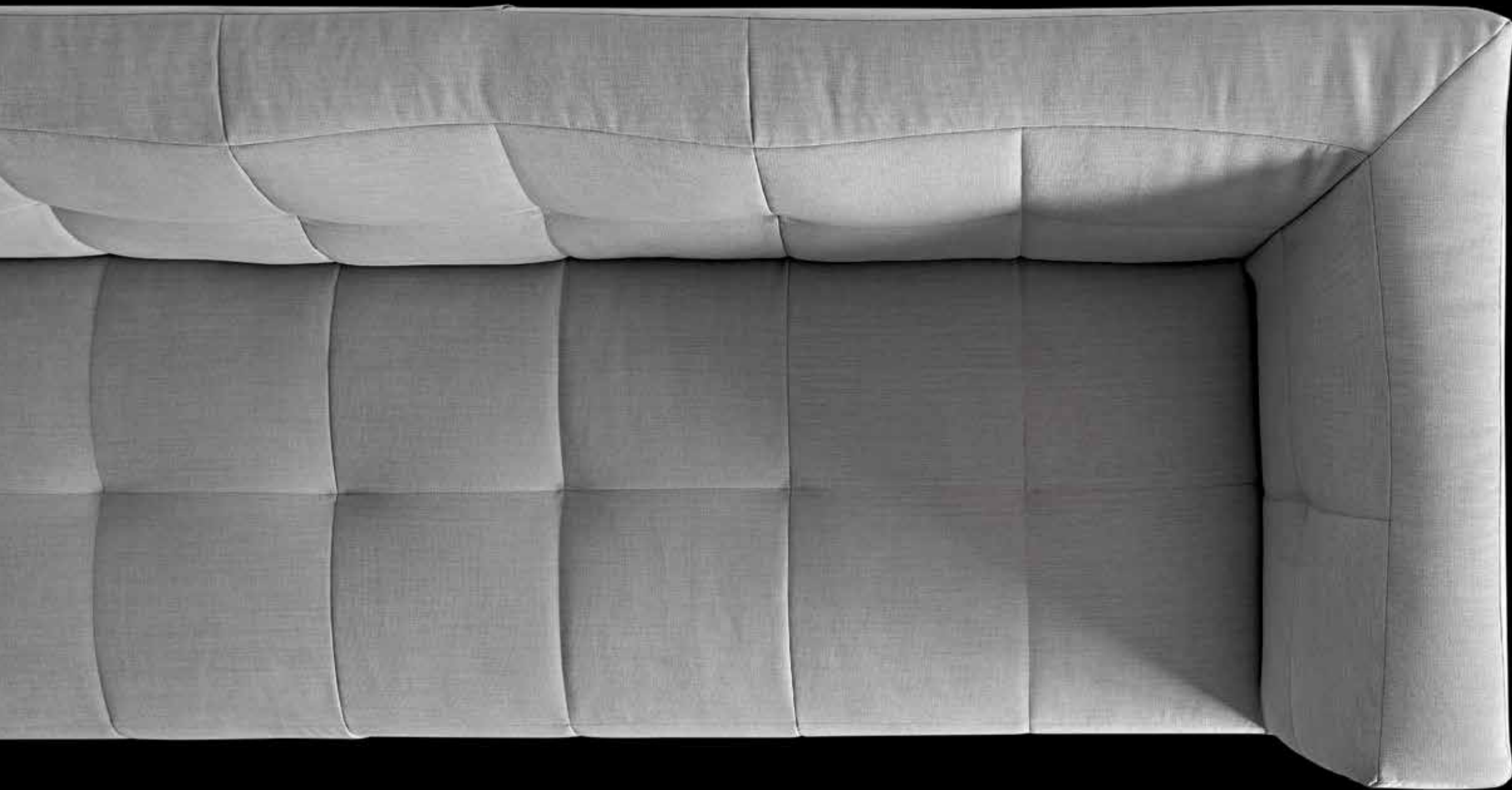

**Scacco**











Scacco cm. 220, cm. 160 + Dude travertino



Scacco cm. 280x396 + Dude emperador



Scacco cm. 280x198 + Dude emperador



Scacco cm. 104



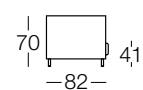

Divani . Sofas  
Canapés . Sofas

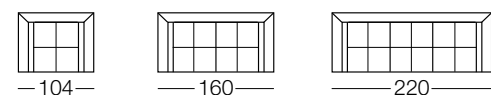

Terminali sx-dx . lh-rh end units  
Pièces terminales gauche/droite . Abschlusselemente links/rechts

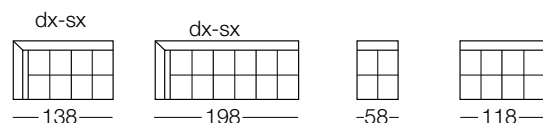

Angolo . Corner unit  
Angle . Eckelement

Pouff . Pouf  
Pouf . Polsterelement

Poltrona . Armchair  
Fauteuil . Sessel

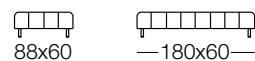

Piedino in legno noce e ottone  
Base in walnut stained wood and brass  
Pied en bois de noyer et laiton  
Füß aus Nussbaumholz und Messing



Piedino in legno naturale e alluminio  
Base in natural wood and aluminium  
Pied en bois naturel et aluminium  
Füß aus Holz in Natursausführung und Aluminium

Composizioni fotografate . Compositions as photographed . Compositions photographiées . Fotografierte Kombinationen

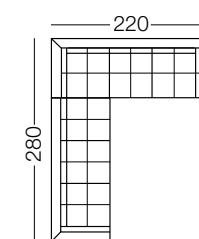

Page 176-177

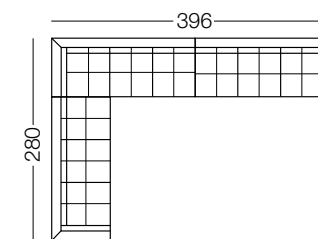

Page 179

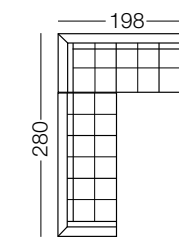

Page 180

IT\_Structura in acciaio e molleggio in acciaio armonico garantiti 10 anni. Imbottitura schienale e seduta in poliuretano espanso a quote differenziate, rivestita in fibra acrilica accoppiata. Elementi completamente svestibili. Piedini in legno massello finitura noce o naturale, puntale in ottone o alluminio lucidato e verniciato, completi di antiscivolo in materiale plastico neutro.

EN\_Steel frame and springs in harmonic steel, guaranteed for 10 years. The padding of the backrest and seat is in polyurethane foam with varying density, upholstered in a backed acrylic fibre. The covers of all elements are fully removable. Feet in solid wood with a walnut or natural finish with a toe-cap in either brass or polished, painted aluminium, complete with non-slips pads in clear plastic.

FR\_Structure en acier et ressorts en acier harmonique garantis pendant 10 ans. Assise et dossier en mousse de polyuréthane expansé de différentes densités, recouvert de fibre acrylique. Éléments entièrement déhoussables. Pieds en bois massif avec finition couleur noyer ou naturel, virole en laiton ou aluminium poli, complets avec antidérapant en matériau plastique neutre.

DE\_Stahlkorpus und Federung aus Federstahl mit 10 Jahren Garantie. Polsterung des Rückenteils und der Sitzfläche aus PU-Schaum unterschiedlicher Dichte, bezogen mit kaschierter Acrylfaserbezug. Elemente vollständig abziehbar. Füße aus Massivholz in Nuss- oder Natursausführung, Metallspitze aus Messing oder poliertem und lackiertem Aluminium, mit neutralem rutschfestem Kunststoffmaterial.

Design  
C. SILVESTRIN



**Le Foglie**











Le Foglie cm. 300



Le Foglie cm. 250

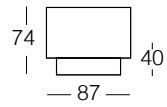

Divani . Sofas  
Canapés . Sofas

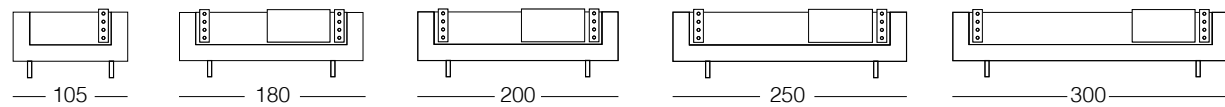

Daybed .

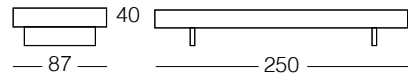

Cuscino . Cushion  
Coussin . Kissen

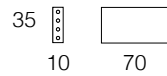

**IT** Struttura in metallo verniciato, garantita 10 anni. Imbottitura in schiuma poliuretana a quote differenziate e rivestita in tessuto protettivo accoppiato. Cuscini volanti in poliuretano e dacron; bottoni in madreperla. Piedi in legno massello di frassino tinto noce; antiscivolo in materiale termoplastico neutro. Rivestimento in tessuto oppure pelle. Il progetto privilegia colori e materiali naturali come il cotone, il lino, la canapa, la lana. Svestibilità totale. Con l'uso la piattaforma della seduta assumerà un aspetto più morbido e vissuto. Quindi il presentarsi di una leggera ondulazione dell'abito è da considerare assolutamente normale.

**EN** Frame in lacquered metal, guaranteed for 10 years. Polyurethane foam padding in different densities, upholstered with a two-layer protective fabric. Loose cushions in polyurethane and dacron; mother-of-pearl buttons. Feet in solid ash in a walnut stain; neutral thermoplastic non-slip glides. Upholstered in fabric or leather.

For this project, natural colours and materials such as cotton, linen, hemp, and wool have been used. Fully removable covers. With use the seating will become softer and more "lived-in"; therefore a slight wrinkling of the covering is perfectly normal.



**FR** Structure en métal laqué, garantie 10 ans. Garnissage en mousse polyuréthane à cotes différenciées et recouvert en tissu de protection double. Coussins volants en polyuréthane et dacron ; boutons en nacre. Pieds en bois de frêne teinté bois de noyer massif; éléments antidérapants en matériau thermoplastique neutre. L'habillage est en tissu ou en cuir. Le projet privilégie les teintes et les matériaux naturels, tels que le coton, le lin, le chanvre et la laine. Entièrement déhoussable. Avec l'usage, l'assise prendra un aspect plus souple et vieilli. Une légère ondulation de l'habillage est donc tout à fait normale.

**DE** Korpus aus lackiertem Metall mit 10 Jahren Garantie. Polsterung aus Schaum-Polyurethan unterschiedlicher Dichte mit kaschiertem Schutzbezug aus Stoff. Die losen Kissen sind aus Polyurethan und Dacron und mit Perlmutterknöpfen versehen. Füße aus Massivholz Esche, Nussbraun gebeizt; mit Rutschsicherung aus neutralem thermoplastischem Material. Der Bezug kann aus Stoff oder Leder sein. Das Design bevorzugt natürliche Farben und Materialien, wie Baumwolle, Leinen, Hanf oder Wolle. Abziehbarkeit: komplett. Mit dem Gebrauch nimmt die Plattform der Sitzfläche ein weicheres, lockereres Aussehen an, daher ist das Auftreten einer leichten Wellung des Stoff- oder Lederbezugs als völlig normal anzusehen.

Design  
R. TAPINASSI



# Rataplan







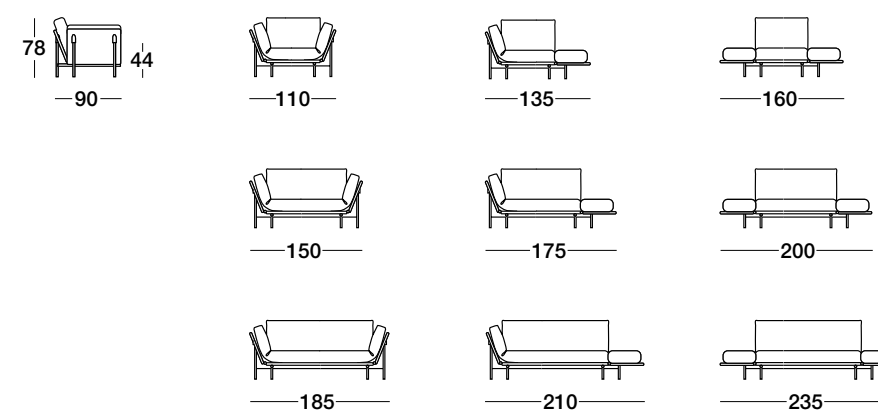

**IT\_**La struttura portante è in acciaio con finitura cromata. La pannellatura è realizzata a stampo in poliuretano integrale. Il cuscino seduta e schienale sono in poliuretano espanso a quote differenziate e fibra poliestere termolegata e rivestiti con tela di cotone bianca. Il rivestimento può essere in tessuto o pelle e la svestibilità è completa. La possibilità di ribaltare il bracciolo avviene tramite un semplice meccanismo in nylon caricato a vetro progettato e brevettato da Dema. Garanzia assoluta di funzionalità nel tempo.

**EN\_**Main structure in chromed steel. Moulded panels in integral polyurethane. Seat and back cushions are in differentiated density of polyurethane foam and heat-bonded polyester fibre, covered with a white cotton fabric. The fully removable covers can be in fabric or leather. A Nylon reinforced with glass joint allows to recline the armrest. This Dema patent guarantees the functionality throughout time.

**FR\_**La structure portante est en acier avec finition chromée. Les panneaux sont moulés en polyuréthane intégral. Coussins assise et dossier en polyuréthane expansé à cotes différenciées et fibre polyester liée à chaud, recouverts d'une toile de coton blanche. L'habillage est en tissu ou en cuir. Entièrement déhoussable. Un simple mécanisme en nylon renforcé avec du verre permet d'incliner l'accoudoir. Ce brevet Dema est un gage de fonctionnalité absolue dans le temps.

**DE\_**Der Korpus ist aus verchromtem Stahl. Die Verkleidung ist aus gepresstem Integral-Polyurethan. Sitzpolster und Rückenlehne aus Schaum-Polyurethan unterschiedlicher Dichte und heiß geklebter Polyesterfaser, bezogen mit weißem Baumwollstoff. Der Bezug ist aus Stoff oder Leder und vollständig abziehbar. Die Armlehne kann mit einem einfachen, von Dema entwickelten und patentierten Mechanismus aus glasverstärktem Nylon gekippt werden. Absolute langfristige Funktionsgarantie.



Design  
M. AGNOLI



**Ottomanne**







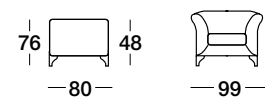

Divani . Sofas  
Canapés . Sofas

Dormeuse sx-dx . lh-rh dormeuse  
Dormeuse gauche/droite . Schlafstuhl links/rechts



Terminali sx-dx . lh-rh end units  
Pièces terminales gauche/droite . Abschlusselemente links/rechts

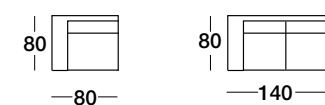

Pouff . Pouf  
Pouf . Polsterelement

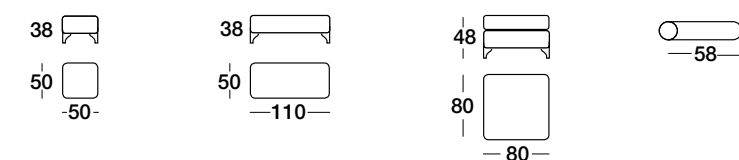

**IT**La struttura è in acciaio imbottita in schiuma poliuretana a quote differenziate e rivestita con tessuto protettivo accoppiato. I cuscini seduta sono realizzati in poliuretano espanso a quote differenziate e fibra poliestere termolegata e rivestiti con tela di cotone bianca. I piedi sono in massello di faggio tinto color noce, completi di antiscivolo in materiale termoplastico neutro. Il rivestimento può essere in tessuto o pelle e la svestibilità è completa.

**EN**The structure is in steel padded with differentiated density of polyurethane foam and covered with a matching protective fabric. The seat cushions are in differentiated density of polyurethane foam and polyester fibre, covered with a white cotton lining. The feet are in beech wood in a walnut stain, complete with non-slip pads in clear thermoplastic. The fully removable covers can be in fabric or leather.

**FR**La structure est en acier, garnie en mousse polyuréthane à cotes différenciées et recouverte en tissu de protection double. Coussins assise en polyuréthane expansé à cotes différenciées et fibre polyester liée à chaud, recouverts d'une toile de coton blanche. Les pieds sont en hêtre teinté couleur noyer massif, complets avec antidérapant en matériau thermoplastique neutre. L'habillage peut être en tissu ou en cuir. Entièrement déhoussable.

**DE**Der Korpus ist aus Stahl mit Polsterung aus Schaum-Polyurethan unterschiedlicher Dichte mit kaschiertem Schutzbezug aus Stoff. Die Sitzflächen sind aus gepresstem Schaum-Polyurethan unterschiedlicher Dichte und heiß geklebter Polyesterfaser, bezogen mit weißem Baumwollstoff. Füße aus Massivholz Buche, Nussbraun gebeizt, mit neutralem thermoplastischem rutschfestem Material. Der Abzug kann aus Stoff oder Leder sein und ist vollständig abziehbar.

Design  
R. SPENCER



**Milord**







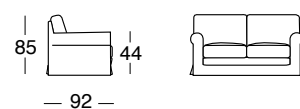

Divani . Sofas  
Canapés . Sofas

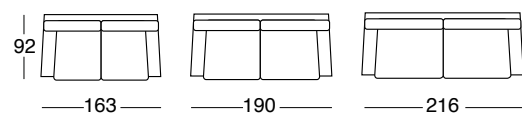

Poltrona . Armchair  
Fauteuil . Sessel

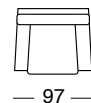

Pouff . Pouf  
Pouf . Polsterelement

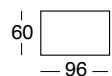

**IT** Struttura in acciaio e molleggio in acciaio armonico garantiti 10 anni. Imbottitura in poliuretano espanso a quote differenziate, rivestita in fibra acrilica accoppiata. Braccioli schiumati a freddo in poliuretano espanso ILPOFLEX™. I cuscini di seduta sono in poliuretano espanso a quote differenziate, rivestiti in falda acrilica, con foderina in cotone e gli schienali in resinpiuma. A richiesta gli schienali possono essere forniti in resinfiocco. Elementi completamente svestibili.

**EN** Steel structure with springs in music wire steel, guaranteed for 10 years. Polyurethane foam padding in different densities, upholstered with composite acrylic fibre. Arms cold-formed in ILPOFLEX™ polyurethane foam. The seat cushions are in polyurethane foam in different densities, upholstered with acrylic fibre layer and a fine cotton cover, while the backs are in Resinpiuma. The backrests can be supplied in Resinfiocco upon request. The covers can be removed from all pieces.

**FR** Structure en acier et suspension en acier harmonique garanties 10 ans. Garnissage en polyuréthane expansé à cotes différenciées, recouvert en fibre acrylique double. Accoudoirs rembourrés avec des mousses à froid en polyuréthane expansé ILPOFLEX™. Les coussins d'assise sont en polyuréthane expansé à cotes différenciées, recouverts en ouate acrylique avec housse en coton et les dossiers sont en Resinpiuma. En option, les dossiers peuvent être fournis en Resinfiocco.Éléments entièrement déhoussables.

**DE** Stahlkorpus und Federung aus Federstahl mit 10 Jahren Garantie. Polsterung aus Schaum-Polyurethan unterschiedlicher Dichte mit kaschierter Acrylfaserabdeckung. Kalt geschäumte Armlehnen aus Schaum-Polyurethan ILPOFLEX™. Die Sitzpolster sind aus Schaum-Polyurethan unterschiedlicher Dichte mit Acrylvliesabdeckung mit Kaschierfutter und die Rückenlehnen sind aus Resinpiuma. Auf Wunsch können die Rückenlehne aus Resinfiocco geliefert werden. Die Elemente sind vollständig abziehbar.

Design  
R. SPENCER



**Giasone**













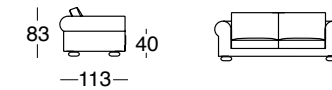

Divani . Sofas  
Canapés . Sofas

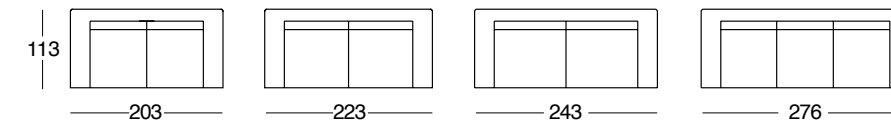

Terminali sx-dx . lh-rh end units  
Pièces terminales gauche/droite . Abschlusselemente links/rechts

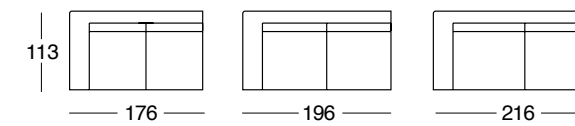

Relax sx-dx . lh-rh chaise longues  
Chaise longue gauche/droite . Chaiselongue links/rechts

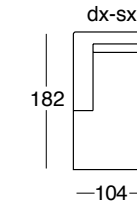

Poltrona . Armchair  
Fauteuil . Sessel



Composizioni fotografate . Compositions as photographed . Compositions photographiées . Fotografierte Kombinationen

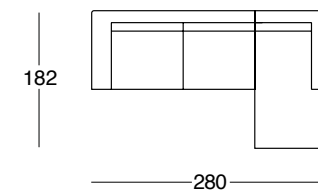

Page 224-225/226



Piedino in ottone cromato  
Base in chrome-plated brass  
Pied en laiton chromé  
Fuß aus verchromtem Messing



Piedino in ottone lucido  
Base in polished brass  
Pied en laiton poli  
Fuß aus poliertem Messing



Piedino in legno tinto noce  
Base in walnut stained wood  
Pied en bois teinté couleur noyer  
Fuß aus Nussbraun gebeiztem Holz

**IT** Struttura in acciaio e molleggio in acciaio armonico garantiti 10 anni. Piedini in ottone cromato, dorato e legno tinto noce. Imbottitura in poliuretano espanso a quote differenziate, rivestita in fibra acrilica accoppiata. I cuscini di seduta sono in poliuretano espanso a quote differenziate, rivestiti in falda acrilica con foderina in cotone e gli schienali in resinpiuma. Elementi completamente svestibili.

**EN** Steel structure with springs in music wire steel, guaranteed for 10 years. Feet in gilded, chrome-plated brass and walnut stained wood. Polyurethane foam padding in different densities, upholstered with composite acrylic fibre. The seat cushions are in polyurethane foam in different densities, upholstered with acrylic fibre layer and a fine cotton cover, while the backs are in Resinpiuma. The covers can be removed from all pieces.

**FR** Structure en acier et suspension en acier harmonique garanties 10 ans. Pieds en laiton chromé, doré and bois teinté couleur noyer. Garnissage en polyuréthane expansé à cotes différenciées, recouvert en fibre acrylique double. Les coussins d'assise sont en polyuréthane expansé à cotes différenciées, recouverts en ouate acrylique avec housse en coton et les dossiers sont en Resinpiuma. Éléments entièrement déhoussables.

**DE** Stahlkorpus und Federung aus Federstahl mit 10 Jahren Garantie. Füße aus vergoldetem, verchromtem Messing und Nussbraun gebeiztem Holz. Polsterung aus Schaum-Polyurethan unterschiedlicher Dichte mit kaschierter Acrylfaserabdeckung. Die Sitzpolster sind aus Schaum-Polyurethan unterschiedlicher Dichte mit Acrylfliesabdeckung mit Kaschierfutter und die Rückenlehnen aus Resinpiuma. Die Elemente sind vollständig abziehbar.



## Medium Lips

Design  
P.G. CAZZANIGA

Laccato lucido . Glossy lacquer  
Laqué brillant . Glanzlackiert

Legno . Wood  
Bois . Holz

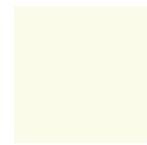
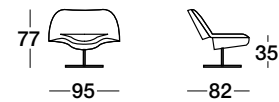

calce



creta

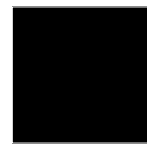

nero



zebrano

IT\_La struttura portante girevole è in acciaio inox satinato completa di antiscivoli in materiale termoplastico neutro. Scocca curvata in multistrati impiallacciata in legno zebrano con verniciatura anti-ingiallente al naturale oppure laccato lucido nei colori in gamma. Imbottitura in poliuretano espanso. Il rivestimento può essere in pelle. Il rivestimento è fisso e non svestibile.

EN\_Swivel base in satin stainless steel, complete with non-slip elements made of thermoplastic materials. Frame in curved multilayer wood with zebrano wood veneer treated with non-yellowing varnish or glossy lacquer available in a range of colours. Stuffed with polyurethane foam. Cover lining is available in leather. Covers are fixed and cannot be removed.

FR\_La structure portante pivotante est en acier inox satiné. Elle comprend des éléments antidérapants en matériau thermoplastique neutre. Coque cintrée en multiplis plaqués en bois zébré avec vernis anti-jaunissement naturel ou laqué brillant dans les couleurs de la gamme. Garnissage en polyuréthane expansé. L'habillage peut être en cuir, fixe et non déhoussable.

DE\_Der drehbare Korpus ist aus satiniertem Edelstahl mit Rutschsicherung aus neutralem thermoplastischem Material. Gebogene Sitzschale aus Zebrano-Schichtholz furnier mit nicht gilbender Lackierung in Naturfarbe oder mit Glanzlackierung in den angebotenen Farben. Polsterung aus Schaum-Polyurethan. Der Bezug kann aus Leder sein. Der Bezug ist fest angebracht und nicht abziehbar.



## Lips

Design  
P.G. CAZZANIGA

Laccato lucido . Glossy lacquer  
Laqué brillant . Glanzlackiert

Legno . Wood  
Bois . Holz



calce



creta



nero



zebrano

IT\_La struttura portante è in acciaio inox satinato completa di antiscivoli in materiale termoplastico neutro. Scocca curvata in multistrati impiallacciata in legno zebrano con verniciatura anti-ingiallente al naturale e leggermente sbiancato oppure laccato lucido nei colori in gamma. Imbottitura in poliuretano espanso. Il rivestimento può essere in pelle. Il rivestimento è fisso e non svestibile.

EN\_Base in satin stainless steel, complete with non-slip elements made of thermoplastic materials. Frame in curved multilayer wood, with slightly bleached zebrano wood veneer treated with non-yellowing varnish or glossy lacquer available in a range of colours. Stuffed with polyurethane foam. Cover lining is available in leather. Covers are fixed and cannot be removed.

FR\_La structure portante est en acier inox satiné. Elle comprend des éléments antidérapants en matériau thermoplastique neutre. Coque cintrée en multiplis plaqués en bois zébré avec vernis anti-jaunissement naturel et légèrement cérusé ou laqué brillant dans les couleurs de la gamme. Garnissage en polyuréthane expansé. L'habillage peut être en cuir, fixe et non déhoussable.

DE\_Der Korpus ist aus satiniertem Edelstahl mit Rutschsicherung aus neutralem thermoplastischem Material. Gebogene Sitzschale aus Zebrano-Schichtholz furnier mit nicht gilbender und weißlich getönter Lackierung in Naturfarbe oder mit Glanzlackierung in den angebotenen Farben. Polsterung aus Schaum-Polyurethan. Der Bezug kann aus Leder sein. Der Bezug ist fest angebracht und nicht abziehbar.





## Boule

Design  
C. BIMBI

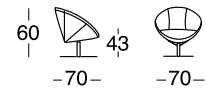

**IT** Poltrona girevole a forma di conchiglia. Struttura in metallo, garantita 10 anni. Imbottitura in poliuretano espanso, rivestita in tessuto protettivo accoppiato. Basamento girevole in trafilato di acciaio cromato. Completamente svestibile.

**EN** Shell-shaped swivel armchair. Metal structure, guaranteed for 10 years. Polyurethane foam padding upholstered with composite protective textile. Swivel base in drawn chrome-plated steel. Fully-removable covers.

**FR** Fauteuil pivotant en forme de coquille. Piétement en métal garanti 10 ans. Garnissage en polyuréthane expansé, recouvert de tissu de protection double. Socle pivotant en acier tréfilé chromé. Entièrement déhoussable.

**DE** Drehsessel in Muschelform. Metallkorpus mit 10 Jahren Garantie. Polsterung aus Schaum-Polyurethan mit kaschiertem Schutzbezug aus Stoff. Drehfußkreuz aus verchromtem gezogenem Stahl. Vollständig abziehbar.



## Flûte

Design  
C. BIMBI

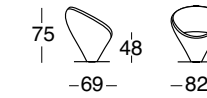

**IT** Poltrona girevole a forma di conchiglia. Struttura in metallo, garantita 10 anni. Imbottitura in poliuretano espanso, rivestita in tessuto protettivo accoppiato. Basamento girevole in trafilato di acciaio cromato. Completamente svestibile.

**EN** Shell-shaped swivel armchair. Metal structure, guaranteed for 10 years. Polyurethane foam padding upholstered with composite protective textile. Swivel base in drawn chrome-plated steel. Fully-removable covers.

**FR** Fauteuil pivotant en forme de coquille. Piétement en métal garanti 10 ans. Garnissage en polyuréthane expansé, recouvert de tissu de protection double. Socle pivotant en acier tréfilé chromé. Entièrement déhoussable.

**DE** Drehsessel in Muschelform. Metallkorpus mit 10 Jahren Garantie. Polsterung aus Schaum-Polyurethan mit kaschiertem Schutzbezug aus Stoff. Drehfußkreuz aus verchromtem gezogenem Stahl. Vollständig abziehbar.





## Elettra

Design  
C. BIMBI

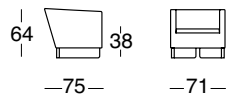

**IT\_**Struttura in acciaio e molleggio in acciaio armonico garantiti 10 anni. Imbottitura in poliuretano espanso a quote differenziate, rivestita in fibra acrilica accoppiata. Cuscino seduta in poliuretano espanso a quote differenziate, rivestito in falda acrilica con foderina in cotone. Basamento in acciaio cromato. Completamente svestibile.

**EN\_**Metal structure with springs in music wire steel, guaranteed for 10 years. Polyurethane foam padding in different densities, upholstered in composite acrylic fibre. Seat cushion of polyurethane foam padding in different densities, upholstered in acrylic layer with cotton cover. Chrome-plated steel base. Fully removable covers.

**FR\_**Structure en acier et suspension en acier harmonique garanties 10 ans. Garnissage en polyuréthane expansé à cotes différenciées, recouvert en fibre acrylique double. Les coussins d'assise sont en polyuréthane expansé à cotes différenciées, recouverts en ouate acrylique avec housse en coton. Socle en acier chromé. Entièrement déhoussable.

**DE\_**Stahlkorpas und Federung aus Federstahl mit 10 Jahren Garantie. Polsterung aus Schaum-Polyurethan unterschiedlicher Dichte mit kaschierter Acrylfaserabdeckung. Sitzpolster aus Schaum-Polyurethan unterschiedlicher Dichte mit Acrylvliesabdeckung mit Kaschierfutter. Fußkreuz aus verchromtem Stahl. Vollständig abziehbar.



## Miami

Design  
M.L. DAINELLI

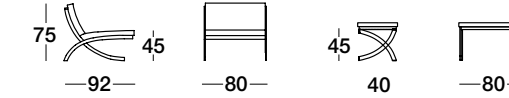

bianco    nero    bulgaro



visone    moro    naturale

**IT\_**Struttura in acciaio cromato. Supporto seduta in cinghie di cuoio nei colori in gamma. La struttura è completa con antiscivoli in materiale termoplastico neutro. Cuscino di seduta e schienale in piuma d'oca certificata e garantita con inserto in poliuretano espanso e rivestito con tela di cotone antipiuma. Rivestimento: tessuto o pelle. Svestibilità: completa.

**EN\_**Structure in chromed steel. Hide leather seat support available in a range of colours. The structure is in neutral thermoplastic material with non-slip end elements. Seat and back cushions in certified and guaranteed goose down with internal support in polyurethane foam, covered with feather-proof cotton fabric. Covers: fabric or leather. Fully removable covers.

**FR\_**Piètement en acier chromé. Support assise en courroies de cuir dans les couleurs de la gamme. Le piètement comprend des éléments antidérapants en matériau thermoplastique neutre. Coussin d'assise et de dossier en duvet d'oie certifié et garanti avec élément en polyuréthane expansé et recouvert d'une toile de coton anti-plume. Habillage : tissu ou cuir. Déhoussable :entièrement..

**DE\_**Korpus aus verchromtem Stahl. Stütze Sitzfläche aus Ledergurten in den angebotenen Farben. Der Korpus ist mit Rutschsicherung aus neutralem thermoplastischem Material versehen. Sitz- und Rückenpolster aus zertifizierten und garantierten Gänsedaunen mit Einlage aus Schaum-Polyurethan und Bezug aus daunendichtem Baumwollstoff. Bezug: Stoff oder Leder. Abziehbarkeit: komplett.



## Dada

Design  
C. BIMBI

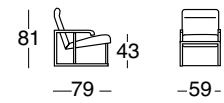

**IT\_**Struttura in metallo e molleggio armonico garantiti 10 anni. La seduta e lo schienale sono formati da un unico elemento. Imbottitura in poliuretano espanso a quote differenziate, rivestita in fibra acrilica accoppiata. Completamente svestibile. Struttura a vista in metallo cromato.

**EN\_**Metal structure with springs in music wire steel, guaranteed for 10 years. The seat and back are made up of a single element. Polyurethane foam padding in different densities, upholstered with composite acrylic fibre. Fully-removable covers. Visible structure in chrome-plated metal.

**FR\_**Piètement en métal et suspension harmonique garantis 10 ans. L'assise et le dossier sont formés d'un seul élément. Garnissage en polyuréthane expansé à cotes différenciées, recouvert en fibre acrylique double. Entièrement déhoussable. Piètement apparent en métal chromé.

**DE\_**Metallkorpus und Federung aus Federstahl mit 10 Jahren Garantie. Sitzfläche und Rückenlehne sind aus einem einzigen Stück geformt. Polsterung aus Schaum-Polyurethan unterschiedlicher Dichte mit kaschierter Acrylfaserabdeckung. Vollständig abziehbar. Sichtbarer Korpus aus verchromtem Metall.



## Dam

Design  
C. BIMBI

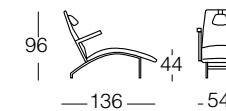

**IT\_**Struttura a vista in frassino colore naturale, moka e noce. Seduta e schienale formati da un unico elemento, hanno una struttura in metallo garantita 10 anni. Imbottitura in poliuretano espanso a quote differenziate, rivestita in fibra acrilica accoppiata. Completamente svestibile.

**EN\_**Visible frame in ash, in a natural, moka or walnut stain. Seat and back are made from a single piece, with a metal structure guaranteed for 10 years. Polyurethane foam padding in different densities, upholstered with composite acrylic fibre. Fully removable covers.

**FR\_**Structure à vue de frêne couleur naturel, moka et noyer. L'assise et le dossier, formés d'un seul élément, ont un piètement en métal garanti 10 ans. Garnissage en polyuréthane expansé à cotes différenciées, recouvert en fibre acrylique double. Entièrement déhoussable.

**DE\_**Sichtbarer Rahmen aus Eschenholz in neutraler Farbe, Mokka oder Nussbraun. Sitzfläche und Rückenlehne sind aus einem einzigen Stück geformt und haben eine Metallstruktur mit 10 Jahren Garantie. Polsterung aus Schaum-Polyurethan unterschiedlicher Dichte mit kaschierter Acrylfaserabdeckung. Vollständig abziehbar.





## Manhattan

Design  
M. L. DAINELLI

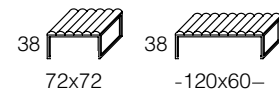

**IT\_**Telaio in acciaio cromato, seduta in poliuretano espanso con supporto in multistrati di legno. Rivestimento in tessuto o pelle. Svestibilità completa.

**EN\_**Structure in chrome-plated steel. Seat in polyurethane foam with multilayer wooden support. Fully removable covers in fabric or leather.

**FR\_**Piètement en acier chromé, assise en polyuréthane expansé avec support en multiplis de bois. Habillage en tissu ou en cuir. Entièrement déhoussable.

**DE\_**Rahmen aus verchromtem Stahl, Sitzfläche aus Schaum-Polyurethan mit Stütze aus Schichtholz. Bezug aus Stoff oder Leder. Vollständig abziehbar.

236



## Arnold

Design  
C. BIMBI

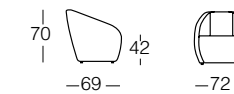

**IT\_**Struttura portante in acciaio imbottita con schiuma poliuretana stampata e rivestita con tessuto protettivo accoppiato. I piedi sono stampati in materiale termoplastico di colore argento e completi di antiscivolo. Il rivestimento è in tessuto o pelle e la svestibilità è totale.

**EN\_**Main structure in steel padded with moulded polyurethane foam and covered with a matching protective fabric. Feet are of silver coloured thermoplastic material, with anti-glide rubbers. Covers in fabric and leather, fully removable.

**FR\_**La structure portante est en acier, garnie en mousse polyuréthane et recouverte en tissu de protection double. Les pieds sont moulés en matériau thermoplastique argenté et ont des éléments antidérapants. L'habillage est en tissu ou en cuir. Entièrement déhoussable.

**DE\_**Korpus aus Stahl mit Polsterung aus Schaum-Polyurethan mit kaschiertem Schutzbezug aus Stoff. Die Füße sind aus silberfarbenem thermoplastischem Material gepresst und mit Rutschsicherung versehen. Der Bezug ist aus Stoff oder Leder und vollständig abziehbar.

237





## Betty

Design  
C. BIMBI

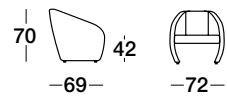

**IT\_**Struttura portante in acciaio imbottita con schiuma poliuretanic stampata e rivestita con tessuto protettivo accoppiato. I piedi sono stampati in materiale termoplastico di colore argento e completi di antiscivolo. Il rivestimento è in tessuto o pelle e la svestibilità è totale.

**EN\_**Main structure in steel padded with moulded polyurethane foam and covered with a matching protective fabric. Feet are of silver coloured thermoplastic material, with anti-glide rubbers. Covers in fabric and leather, fully removable.

**FR\_**La structure portante est en acier, garnie en mousse polyuréthane et recouverte en tissu de protection double. Les pieds sont moulés en matériau thermoplastique argenté et ont des éléments antidérapants. L'habillage est en tissu ou en cuir. Entièrement déhoussable.

**DE\_**Korpus aus Stahl mit Polsterung aus Schaum-Polyurethan mit kaschiertem Schutzbezug aus Stoff. Die Füße sind aus silberfarbenem thermoplastischem Material gepresst und mit Rutsicherung versehen. Der Bezug ist aus Stoff oder Leder und vollständig abziehbar.



## Cuccia

Design  
ARCHIVIO DEMA

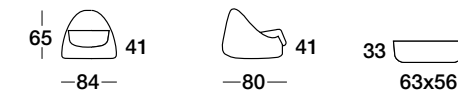

**IT\_**La struttura è realizzata completamente con schiuma poliuretanic stampata senza inserto interno e con una base in legno multistrato; il tutto è rivestito con tessuto protettivo accoppiato. Il cuscino seduta è anch'esso in schiuma poliuretanic stampata e rivestito con tessuto protettivo. I piedini sono stampati in materiale termoplastico di colore argento e completi di antiscivoli. Il rivestimento può essere in tessuto, la svestibilità è completa.

**EN\_**Structure without internal support, fully realized with moulded polyurethane foam and multilayer wooden base; all covered with a double protective fabric. The seat cushion is in moulded polyurethane foam and covered with a protective fabric. Feet are in silver coloured thermoplastic material, with anti-glide rubbers. Fully removable covers also come in fabric.

**FR\_**La structure portante est en acier, garnie en mousse polyuréthane à cotes différenciées et recouverte en tissu de protection double. Les pieds sont moulés en matériau thermoplastique argenté et ont des éléments antidérapants. L'habillage est en tissu. Entièrement déhoussable.

**DE\_**Der Korpus ist ganz aus gepresstem Schaum-Polyurethan ohne Einlage und mit einem Unterbau aus Schichtholz; das Ganze mit kaschiertem Schutzbezug aus Stoff. Das Sitzpolster ist ebenfalls aus gepresstem Schaum-Polyurethan mit Schutzbezug aus Stoff. Die Füße sind aus silberfarbenem thermoplastischem Material gepresst und mit Rutsicherung versehen. Der Bezug ist aus Stoff und vollständig abziehbar.



## Libero

Design  
R. SPENCER

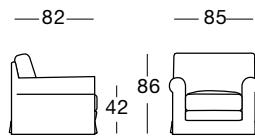

IT\_Structura in metallo e molleggio in acciaio armonico garantita 10 anni. Imbottitura in poliuretano espanso a quote differenziate, rivestita in fibra acrilica accoppiata. Braccioli schiumati a freddo in poliuretano espanso Ilopflex. Cuscini seduta e schienale in poliuretano espanso a quote differenziate rivestiti in falda acrilica con foderina in cotone. Completamente sfoderabile.

EN\_Metal frame and springs in harmonic steel, guaranteed for 10 years. The padding is in polyurethane foam with varying density, upholstered in a backed acrylic fibre. The armrests are cold foamed in Ilopflex expanded polystyrene. The cushions of the seat and backrest are in expanded polystyrene with varying density, upholstered in a layer of acrylic fibre with a cotton backing. Fully removable covers.

FR\_Structure en métal et ressorts en acier harmonique garantie 10 ans. Rembourrage en mousse de polyuréthane expansé à densité différenciée en fibre acrylique. Accoudoirs en mousse de polyuréthane expansé Ilopflex. Coussins assise et dossier en mousse de polyuréthane expansé à densité différenciée en fibre acrylique recouverts d'une couche en acrylique avec doublure en coton. entièrement déhoussable.

DE\_Stahlkorpus und Federung aus Federstahl mit 10 Jahren Garantie. Polsterung aus PU-Schaum unterschiedlicher Dichte, bezogen mit kaschiertem Acrylfaserbezug. Kalt geschäumte Armlehnen aus PU-Schaum Ilopflex. Die Sitzkissen und die Rückenlehne sind aus PU-Schaum unterschiedlicher Dichte mit Acrylfliesabdeckung mit Baumwollbezug. Vollständig abziehbar.



## Elio

Design  
R. SPENCER

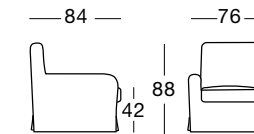

IT\_Structura in metallo e molleggio in acciaio armonico garantita 10 anni. Imbottitura in poliuretano espanso a quote differenziate, rivestita in fibra acrilica accoppiata. Braccioli schiumati a freddo in poliuretano espanso Ilopflex. Cuscini seduta e schienale in poliuretano espanso a quote differenziate rivestiti in falda acrilica con foderina in cotone. Completamente sfoderabile.

EN\_Metal frame and springs in harmonic steel, guaranteed for 10 years. The padding is in polyurethane foam with varying density, upholstered in a backed acrylic fibre. The armrests are cold foamed in Ilopflex expanded polystyrene. The cushions of the seat and backrest are in expanded polystyrene with varying density, upholstered in a layer of acrylic fibre with a cotton backing. Fully removable covers.

FR\_Structure en métal et ressorts en acier harmonique garantie 10 ans. Rembourrage en mousse de polyuréthane expansé à densité différenciée en fibre acrylique. Accoudoirs en mousse de polyuréthane expansé Ilopflex. Coussins assise et dossier en mousse de polyuréthane expansé à densité différenciée en fibre acrylique recouverts d'une couche en acrylique avec doublure en coton. entièrement déhoussable.

DE\_Stahlkorpus und Federung aus Federstahl mit 10 Jahren Garantie. Polsterung aus PU-unterschiedlicher Dichte, bezogen mit kaschiertem Acrylfaserbezug. Kalt geschäumte Armlehnen aus PU-Schaum Ilopflex. Die Sitzkissen und die Rückenlehne sind aus PU-Schaum unterschiedlicher Dichte mit Acrylfliesabdeckung mit Baumwollbezug. Vollständig abziehbar.





## Cubic

Design  
R. TAPINASSI\_M. MANZONI

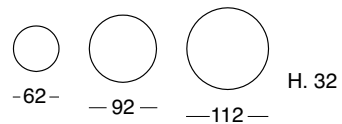

**IT\_**Struttura in metallo garantita 10 anni. Imbottitura in poliuretano espanso a quote differenziate, rivestita in fibra acrilica accoppiata. Piano in laminato colore nero lucido. Elementi completamente svestibili.

**EN\_**Metal structure guaranteed for 10 years. Polyurethane foam padding in different densities, upholstered with composite acrylic fibre. Glossy black laminated top. The covers can be removed from all pieces.

**FR\_**Structure en acier garanti 10 ans. Garnissage en polyuréthane expansé à cotes différenciées, recouvert en fibre acrylique double. Plateau en stratifié noir brillant. Éléments entièrement déhoussables.

**DE\_**Metallkorpus mit 10 Jahren Garantie. Polsterung aus Schaum-Polyurethan unterschiedlicher Dichte mit kaschierter Acrylfaserabdeckung. Platte aus glänzend schwarzem Laminat. Die Elemente sind vollständig abziehbar.



## Simple

Design  
R. SPENCER

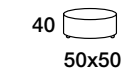

**IT\_**La struttura portante è in poliuretano espanso ad alta densità con supporto di base in multistrati di betulla, completo di antiscivoli in materiale termoplastico neutro. Il rivestimento può essere in tessuto o pelle e la svestibilità è totale.

**EN\_**The main structure is high-density polyurethane foam with birch multilayer support, with neutral thermoplastic non-slip feet. Covers are available in fabric or leather. All covers are fully removable.

**FR\_**La structure portante est en polyuréthane expansé haute densité avec support de base en multiplis de bouleau. Elle a des éléments antidérapants en matériau thermoplastique neutre. L'habillage peut être en tissu ou en cuir. Entièrement déhoussable.

**DE\_**Der Korpus ist aus hochdichtem Schaum-Polyurethan mit Unterbau aus Birken-Schichtholz, mit Rutschsicherung aus neutralem thermoplastischem Material. Der Bezug ist aus Stoff oder Leder und vollständig abziehbar.





## Cubo

Design  
R. SPENCER

38  38

**IT** Realizzato in poliuretano espanso ad alta densità con supporto in multistrato di betulla e completo di piedini antiscivolo in materiale stampato termoplastico neutro. Il rivestimento può essere in tessuto o pelle e la svestibilità è completa.

**EN** Structure in high density polyurethane foam with birch multilayer support and neutral thermoplastic non-slip glides. Covers in fabric or leather. All covers are fully removable.

**FR** Réalisé en polyuréthane expansé haute densité avec support en bouleau multiplis et pieds antidérapants en matériau moulé thermoplastique neutre. L'habillage peut être en tissu ou en cuir. Entièrement déhoussable.

**DE** Hergestellt aus hochdichtem Schaum-Polyurethan mit Unterbau aus Birken-Schichtholz und mit rutschfesten Füßen aus neutralem thermoplastischem Pressmaterial. Der Bezug ist aus Stoff oder Leder und vollständig abziehbar.



## Hotello

Design  
C. BIMBI

Laccato lucido . Glossy lacquer  
Laqué brillant . Glanzlackiert

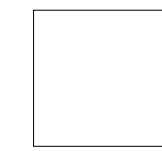

bianco



creta



nero

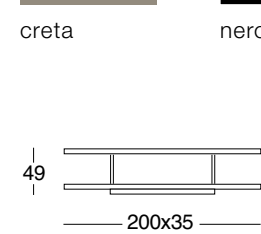
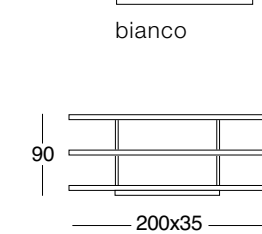
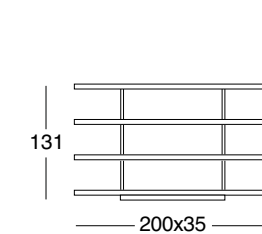
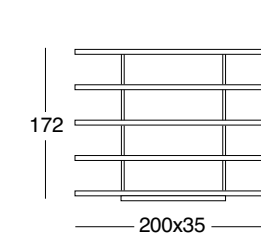
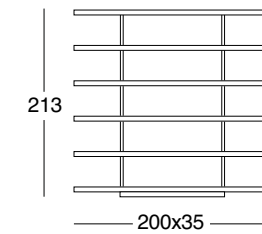

**IT** Realizzata con piani di legno tamburato da 50 mm. Le parti strutturali sono realizzate in acciaio inox satinato. I piani sono laccato lucido nei colori di gamma.

**EN** Produced with 50mm hollow core shelves. Structural elements in satin-finish stainless steel. The shelves have a gloss finish chosen from the colour range.

**FR** Réalisée avec des étagères en bois plaqué de 50 mm. Les parties structurelles sont réalisées en acier inoxydable satiné. Les étagères sont laquées brillantes dans les couleurs de la gamme.

**DE** Hergestellt aus 50 mm dicken Fachböden mit Hohlraummittellage. Die Strukturteile sind aus satiniertem Edelstahl. Die Fachböden sind in den angebotenen Farben glanzlackiert.



## Deck

Design  
P.G. CAZZANIGA

Laccato lucido . Glossy lacquer  
Laqué brillant . Glanzlackiert

Legno . Wood  
Bois . Holz

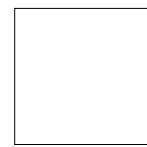
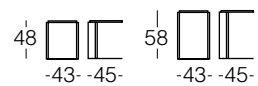

bianco



creta



nero



zebrano

**IT** La struttura è in acciaio inox satinato completa di antiscivolo in materiale termoplastico stampato neutro. Il piano di appoggio può essere in legno multistrato impiallacciato con legno zebrano con verniciatura anti-ingiallente e leggermente sbiancato; in legno multistrato laccato lucido nei colori in gamma.

**EN** Satin finish stainless steel structure with non-slip elements made of neutral moulded thermoplastic material. The table has a top of multilayer wood with slightly bleached zebrano veneer treated with non-yellowing varnish; glossy lacquer multilayer wood available in a range of colours.

**FR** Le piétement est en acier inox satiné avec éléments antidérapants en matériau thermoplastique moulé neutre. Le plateau peut être en bois multiplis plaqué avec du bois zébré vernis anti-jaunissement et légèrement cérusé ; en bois multiplis laqué brillant dans les couleurs de la gamme.

**DE** Der Korpus ist aus satiniertem Edelstahl mit Rutschsicherung aus neutralem thermoplastischem Pressmaterial. Die Auflagefläche kann aus Zebrano-Schichtholz furnier mit nicht gilbender und weißlich getönter Lackierung oder aus Schichtholz mit Glanzlackierung in den angebotenen Farben sein.



## Kuadro

Design  
ARCHIVIO DEMA

Laccato lucido . Glossy lacquer  
Laqué brillant . Glanzlackiert

32

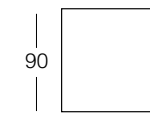

-90-



bianco



creta



nero

**IT** Tavolino in MDF laccato lucido nei colori in gamma.

**EN** Glossy lacquer MDF table available in a range of colours.

**FR** Table basse en MDF laqué brillant dans les couleurs de la gamme.

**DE** Tischchen aus MDF mit Glanzlackierung in den angebotenen Farben.





## Dude emperador

Design  
G. GUALTIEROTTI

Marmo . Marble  
Marbre . Marmor



dark emperador

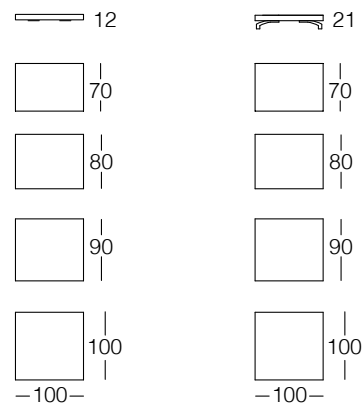

IT\_Piano in Marmo emperador dark con struttura interna scatolare in multistrato. Piede alluminio lucido oppure in materiale plastico

EN\_Top in emperador dark marble, with an internal box-like structure in plywood. Base in shiny aluminium or plastic.

FR\_Plateau de marbre emperador foncé avec structure interne à boîte de contreplaqué. Pied en aluminium poli ou en plastique.

DE\_Emperador Dark-Marmorplatte mit einem rechteckigen inneren Rahmen aus Schichtholz. Fuß aus poliertem Aluminium oder aus Kunststoff.

## Dude cuoio

Design  
G. GUALTIEROTTI

Cuoio . Leather  
Cuir . Leder



sabbia naturale



moka nero

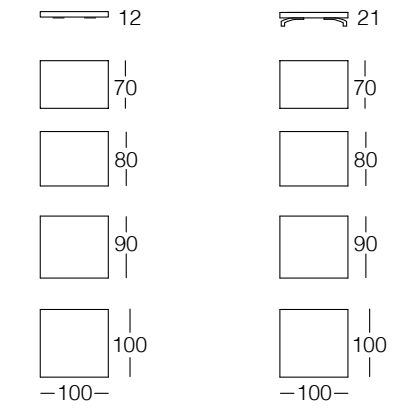

IT\_Piano in cuoio con cuciture a vista con struttura interna scatolare in multistrato. Piede alluminio lucido oppure in materiale plastico.

EN\_Top in top-stitched leather, with an internal box-like structure in plywood. Base in shiny aluminium or plastic.

FR\_Plateau en cuir avec coutures apparentes avec structure interne à boîte de contreplaqué. Pied en aluminium poli ou en plastique.

DE\_Platte aus Leder mit Sichtnähten und einem rechteckigen inneren Rahmen aus Schichtholz. Fuß aus poliertem Aluminium oder aus Kunststoff.





## Dude travertino

Design  
G. GUALTIEROTTI

Travertino . Travertine  
Travertin . Travertin .



travertino

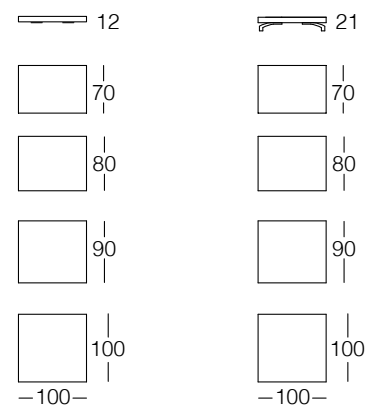

IT\_Piano in travertino con struttura interna scatolare in multistrato. Piede alluminio lucido oppure in materiale plastico.

EN\_Top in travertine, with an internal box-like structure in plywood. Base in shiny aluminium or plastic.

FR\_Plateau de travertin avec structure interne à boîte de contreplaqué. Pied en aluminium poli ou en plastique.

DE\_Platte aus Leder mit Sichtnähten und einem rechteckigen inneren Rahmen aus Schichtholz. Fuß aus poliertem Aluminium oder aus Kunststoff.



## Round

Design  
R. SPENCER

Laccato lucido . Glossy lacquer  
Laqué brillant . Glanzlackiert

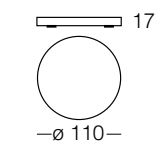

bianco

creta

nero

IT\_Tavolino in MDF laccato lucido nei colori in gamma.

EN\_Glossy lacquer MDF table available in a range of colours.

FR\_Table basse en MDF laqué brillant dans les couleurs de la gamme.

DE\_Tischchen aus MDF mit Glanzlackierung in den angebotenen Farben.



## Pet's bed

Design  
G. GUALTIEROTTI

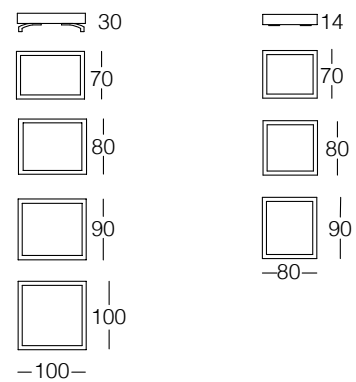

IT\_Contenitore in multistrato gommato rivestito in ecopelle. Trapunta imbottita in fibra sintetica. Piede alluminio lucido oppure in materiale plastico.

EN\_Container in layered rubber covered in eco-leather. Quilt with synthetic filling. Base in shiny aluminium or plastic.

FR\_Conteneur contreplaqué avec roues couvert en eco-cuir. Doudoune rembourrée en fibre synthétique. Pied en aluminium poli ou en plastique.

DE\_Behältnis aus gummiertem Schichtholz mit Kunstlederbezug. Steppdecke mit Synthetikfaserpolsterung. Fuß aus poliertem Aluminium oder aus Kunststoff.



## Sandy

Design  
R.SPENCER

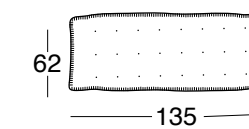

Colori cucitura a contrasto . Thread colours for contrasting stitching . Couleurs du fil pour couture contrastée . Garnfarben für die Kontrastnaht



IT\_Trapuntino imbottito in fibra acrilica con cuciture in contrasto.

EN\_Quilt in acrylic fibre, top-stitched in a contrasting colour.

FR\_Doudoune rembourrée en fibre acrylique avec coutures en contraste.

DE\_Steppdecke mit Acrylfaserpolsterung mit Kontrastnähten.





## Cuscini (dacron)



cm. 60 x 60  
COD. 301 - T  
COD. 313 - P



cm. 60 x 60  
COD. 302 - T  
COD. 314 - P



cm. 50 x 50  
COD. 303 - T  
COD. 315 - P



cm. 50 x 50  
COD. 304 - T  
COD. 316 - P



cm. 45 x 45  
COD. 305 - T  
COD. 317 - P



cm. 45 x 45  
COD. 306 - T  
COD. 318 - P



cm. 60 x 30  
COD. 307 - T  
COD. 319 - P



cm. 60 x 30  
COD. 308 - T  
COD. 320 - P



cm. 50 x 30  
COD. 309 - T  
COD. 321 - P



cm. 50 x 30  
COD. 310 - T  
COD. 322 - P



cm. 30 x 40  
COD. 311 - T  
COD. 323 - P



cm. 30 x 40  
COD. 312 - T  
COD. 324 - P

T\_ TESSUTO . FABRIC . TISSU . STOFF    P\_ PELLE . LEATHER . CUIR . LEDER

Bordino decorativo . Decorative trim . Bourrelet décoratif . Dekorative Einfassung







ARNÒ 258



BOBOLI 322



CAMBIO 296



CARLETTO PLUS 370



CARLOTTA PLUS 364



CAROSELLO 358



ELIO 286



GHOST 320



LIBERO 306



MEMO 314



NOTTEDÌ 268



METRONOTTE 276



SLALOM 340



SURF 348



PLUTO 376



LEONARDO 382

Collezione Dema divani+divani letto

Collezione Dema divani+divani letto

Design  
GUIDO ROSATI



**Arnò**











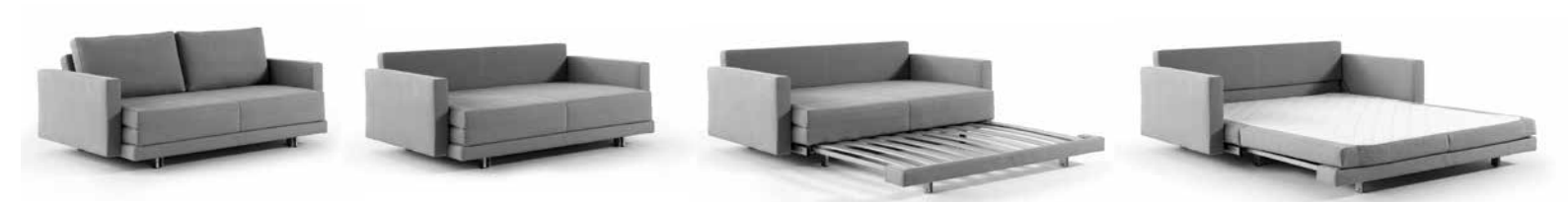

Divani trasformabili in letto . Sofa beds . Canapés convertibles . Schlafcouchen

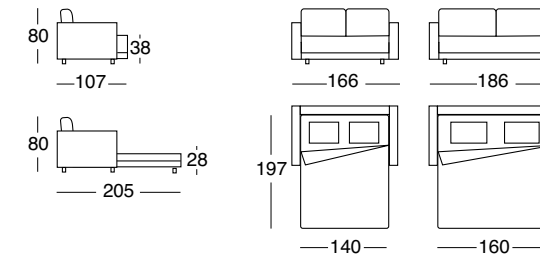

Modello depositato . Registered model . Modèle déposé . Eingetragenes Modell

**IT** Divano trasformabile in letto cm.140/160, completamente sfoderabile. La struttura portante è in tubolare di acciaio, mentre il molleggio è realizzato con doghe di legno. Imbottitura in Poliuretano espanso con ovattatura in fibre acriliche. Cuscini schienale in piuma d'oca canalizzata. Materasso H. cm 11 in Poliuretano espanso a quote differenziate. Su richiesta il materasso può essere fornito in Polilatex.

**EN** Sofa bed with bed cm.140/ cm.160. Fully removable cover. Steel tube-shaped main structure, spring system in wooden slats. Polyurethane foam padding covered in acrylic fibre wadding. Baffled down back cushions. Different density polyurethane foam mattress of 11 H. cm. The mattress may be supplied to order in Polilatex HT with natural latex.

**FR** Canapé convertible cm.140/160. Entièrement déhoussable. Structure portante en tubulaire d'acier. Suspension avec lattes en bois. Garnissage en polyuréthane expansé avec garniture en fibre acrylique. Coussins du dossier en duvet cloisonné. Matelas en polyuréthane expansé à cotes différenciées de 11 cm. En option, le matelas peut être fourni en Polilatex.

**DE** Schlafcouch 140/160 cm, komplett abziehbar. Korpus aus Stahlrohr, Federung mit Holzlattenrost. Polsterung aus Polyurethanschaum mit Acrylvliesabdeckung. Rückenlehne mit kanalisierter Gaensedaune. Matratze H 11cm aus Polyurethanschaum unterschiedlicher Dichte. Auf Wunsch kann die Matratze auch in Polylatex geliefert werden.





**Nottedi**









## NOTTEDÌ



Divani trasformabili in letto . Sofa beds . Canapés convertibles . Schlafcouchen

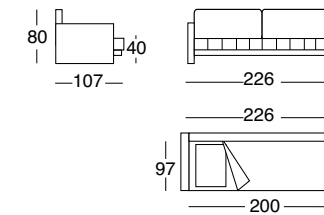

**IT** Divano trasformabile in letto singolo completamente sfoderabile. La struttura portante è in tubolare di acciaio, mentre il molleggio è realizzato con doghe di legno. Imbottitura in Poliuretano espanso con ovattatura in fibre acriliche. Cuscini schienale in piuma d'oca canalizzata. Viene fornito di trapunta. Materasso H. cm. 11 in Poliuretano espanso. Su richiesta il materasso può essere fornito in Polilatex.

**EN** Sofa bed with single bed. Fully removable cover. Steel tube-shaped main structure, spring system in wooden slats. Polyurethane foam padding covered in acrylic fibre wadding. Baffled down back cushions. The bed set comes complete with a quilt. Polyurethane foam mattress of 11 H. cm. The mattress may be supplied to order in Polilatex HT with natural latex.

**FR** Canapé convertible en lit à une place. Entièrement déhoussable. Structure portante en tubulaire d'acier. Suspension avec lattes en bois. Garnissage en polyuréthane expansé avec garniture en fibre acrylique. Coussins du dossier en duvet cloisonné. Il est livré avec une couette. Matelas en polyuréthane expansé de 11 cm. En option, le matelas peut être fourni en Polilatex.

**DE** Schlafcouch als Einzelbett, komplett abziehbar. Korpus aus Stahlrohr, Federung mit Holzlattenrost. Polsterung aus Polyurethan-Schaum mit Acryl-Vliesabdeckung. Rückenkissen aus kanalisierter Gaensedaune. Ausgestattet mit Steppdecke. Matratze H 11cm aus Polyurethan-Schaum. Auf Wunsch kann die Matratze auch in Polylatex geliefert werden.



**Metronotte**













## METRONOTTE



### Divani trasformabili in letto . Sofa beds . Canapés convertibles . Schlafcouchen

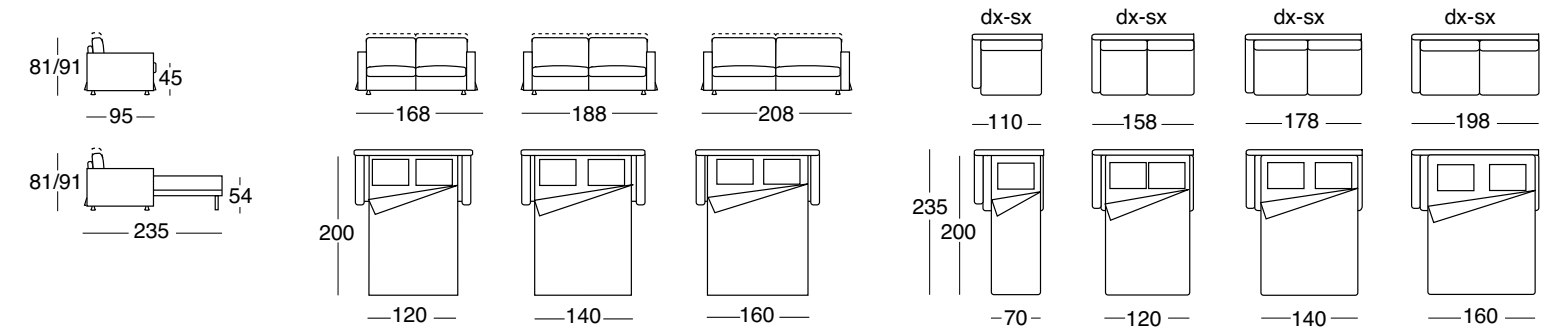

**IT** Divano trasformabile in letto completamente sfoderabile. Struttura portante in tubolare d'acciaio. Meccanica estraibile con rete elettrosaldata e plastificata. Imbottitura in Poliuretano espanso con ovattatura in fibre acriliche. Cuscini seduta e schienale in Poliuretano espanso a quote differenziate rivestiti in falda acrilica termolegata. Materasso H. cm. 13 a molle. Su richiesta il materasso può essere fornito in Polilatex.

**EN** Sofa bed with fully removable cover. Steel tube-shaped main structure. Extractable mechanism with an electrically welded plastic-coated base. Polyurethane foam padding covered in acrylic fibre wadding. Different density polyurethane foam seat and back cushions covered with a layer of heat-boned acrylic. 13 cm high spring mattress. The mattress may be supplied to order in Polilatex HT with natural latex.

**FR** Canapé convertible. Entièrement déhoussable. Structure portante en tubulaire d'acier. Mécanisme escamotable avec sommier électrosoudé plastifié. Garnissage en polyuréthane expansé avec garniture en fibre acrylique. Coussins assise et dossier en polyuréthane expansé à cotes différenciés, recouverts en fibre acrylique thermoliée. Matelas à ressorts de 13 cm. En option, le matelas peut être fourni en Polilatex.

**DE** Schlafcouch komplett abziehbar. Korpus aus Stahlrohr. Mechanismus fuer ausziehbaren elektrogeschweissten und plastifizierten Sprungrahmen. Polsterung aus Polyurethan-Schaum mit Acrylvliesabdeckung. Sitz- und Rueckenkissen aus Polyurethan-Schaum unterschiedlicher Dichte mit heiss geklebter Acrylvliesabdeckung. Federkernmatratze H 13 cm. Auf Wunsch kann die Matratze auch in Polylatex geliefert werden.

### Poltrona e divani fissi . Sofas and armchairs . Fauteuil et canapés fixes . Sessel und normale Sofas

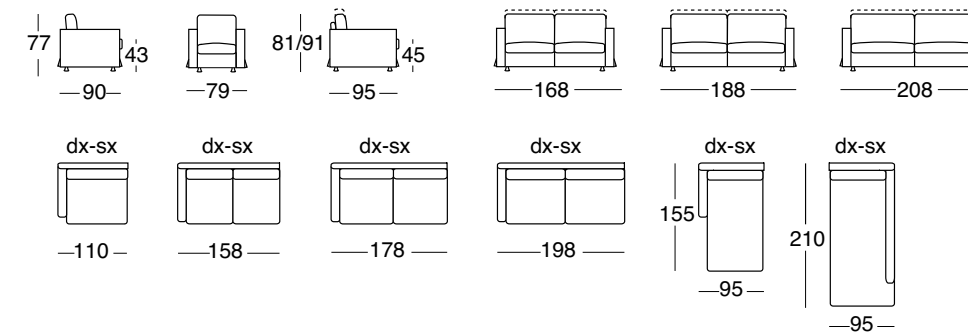

**IT** Struttura portante in tubolare di acciaio garantito 10 anni. Imbottitura in Poliuretano espanso a quote differenziate con ovattatura in fibre acriliche. Molleggio seduta in acciaio armonico. Cuscini seduta e schienali in Poliuretano espanso a quote differenziate rivestiti in falda acrilica termolegata. Elementi completamente sfoderabili. Lo schienale è dotato di un semplice meccanismo che permette il sollevamento manuale del cuscino restando seduti.

**EN** 10 years guaranteed steel tube-shaped main structure. Polyurethane foam padding covered in acrylic fibre wadding. The spring system of the seat is in harmonious steel. Different density polyurethane foam seat and back cushions covered with a layer of heat-boned acrylic. Fully removable covers. The back is equipped with a simple mechanism that enables manual lifting of the back cushion when seated.

**FR** Structure portante en tubulaire d'acier garantie 10 ans. Garnissage en polyuréthane expansé à cotes différenciées avec garniture en fibre acrylique. La suspension est réalisée en acier harmonique. Coussins assise et dossier en polyuréthane expansé à cotes différenciés, recouverts en fibre acrylique thermoliée. Entièrement déhoussable. Mécanisme facile à utiliser permettant de soulever manuellement le coussin du dossier sans se lever.

**DE** Untergestell aus Stahlrohr mit 10 Jahren Garantie. Polsterung aus Polyurethan-Schaum unterschiedlicher Dichte mit Wattierung aus Acrylfaser. Federung der Sitzfläche aus Federstahl. Sitz- und Rueckenkissen aus Polyurethan-Schaum unterschiedlicher Dichte mit heiss geklebter Acrylvliesabdeckung. Die Elemente sind komplett abziehbar. Die Rueckenlehne hat einen einfachen Mechanismus, der das manuelle Anheben des Kissens im Sitzen ermöglicht.





**Elio**













**ELIO**



**Divani trasformabili in letto . Sofa beds . Canapés convertibles . Schlafcouchen**

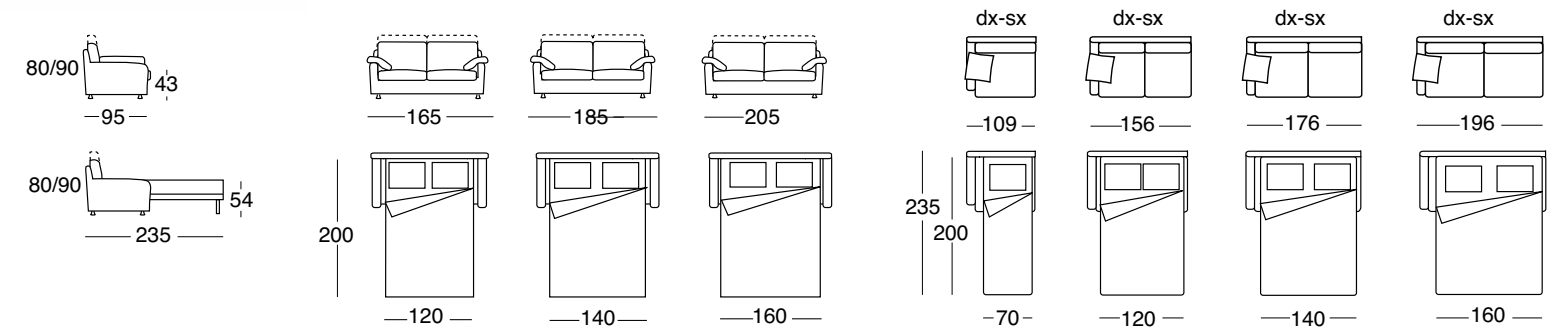

**IT** Divano trasformabile in letto completamente sfoderabile. Struttura portante in tubolare d'acciaio. Meccanica estraibile con rete elettrosaldata e plastificata. Imbottitura in Poliuretano espanso con ovattatura in fibre acriliche. Braccioli schiumati a freddo in Poliuretano espanso. Cuscini seduta e schienale in Poliuretano espanso a quote differenziate rivestiti in falda acrilica termolegata. Materasso H. cm. 13 a molle. Su richiesta il materasso può essere fornito in Polilatex.

**EN** Sofa bed with fully removable cover. Steel tube-shaped main structure. Extractable mechanism with an electrically welded plastic-coated base. Polyurethane foam padding covered in acrylic fibre wadding. Cold foamed arms filled with Polyurethane foam. Different density polyurethane foam seat and back cushions covered with a layer of heat-boned acrylic. 13 cm high spring mattress. The mattress may be supplied to order in Polilatex HT with natural latex.

**FR** Canapé convertible. Entièrement déhoussable. Structure portante en tubulaire d'acier. Mécanisme escamotable avec sommier électrosoudé plastifié. Garnissage en polyuréthane expansé avec garniture en fibre acrylique. Accoudoirs rembourrés avec des mousses à froid en polyuréthane expansé. Coussins assise et dossier en polyuréthane expansé à cotes différenciés, recouverts en fibre acrylique thermoliée. Matelas à ressorts de 13 cm. En option, le matelas peut être fourni en Polilatex.

**DE** Schlafcouch komplett abziehbar. Korpus aus Stahlrohr. Mechanismus für ausziehbaren elektrogeschweissten und plastifizierten Sprungrahmen. Polsterung aus Polyurethan-Schaum mit Acryl-Vliesabdeckung. Armlehnen aus Polyurethan-Kaltschaum. Sitz- und Rückenklissen aus Polyurethan-Schaum unterschiedlicher Dichte mit heiss geklebter Acryl-Vliesabdeckung. Federkernmatratze H 13cm. Auf Wunsch kann die Matratze auch in Poylatex geliefert werden.

**Poltrona e divani fissi . Sofas and armchairs . Fauteuil et canapés fixes . Sessel und normale Sofas**

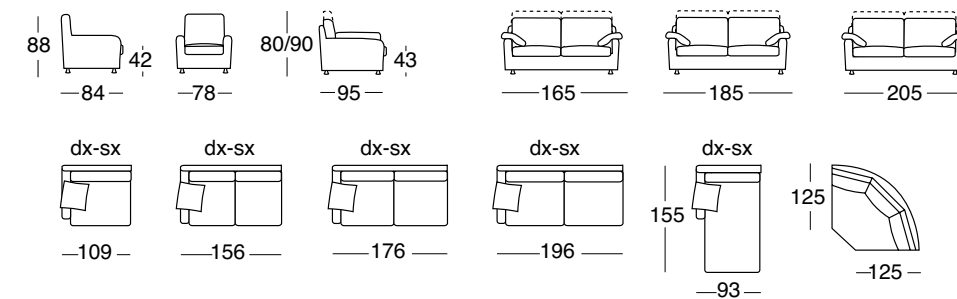

Versione con gonna  
Version with valance  
Version avec jupe  
Version mit Schürze

Versione piede a vista  
Version without valance  
Version pied apparent  
Version mit sichtbarem Fuß



**IT** Struttura portante in tubolare di acciaio garantito 10 anni. Imbottitura in Poliuretano espanso a quote differenziate con ovattatura in fibre acriliche. Molleggio seduta in acciaio armonico. Braccioli schiumati a freddo in Poliuretano espanso. Cuscini seduta e schienali in Poliuretano espanso a quote differenziate rivestiti in falda acrilica termolegata. Elementi completamente sfoderabili. Lo schienale è dotato di un semplice meccanismo che permette il sollevamento manuale del cuscino restando seduti.

**EN** 10 years guaranteed steel tube-shaped main structure. Polyurethane foam padding covered in acrylic fibre wadding. The spring system of the seats is in harmonious steel. Cold foamed arms with polyurethane foam. Different density polyurethane foam seat and back cushions are covered with a layer of heat-boned acrylic. Fully removable covers. The back is equipped with a simple mechanism that enables manual lifting of the back cushion when seated.

**FR** Structure portante en tubulaire d'acier garantie 10 ans. Garnissage en polyuréthane expansé à cotes différenciées avec garniture en fibre acrylique. La suspension est réalisée en acier harmonique. Accoudoirs rembourrés avec des mousses à froid en polyuréthane expansé. Coussins assise et dossier en polyuréthane expansé à cotes différenciés, recouverts en fibre acrylique thermoliée. Entièrement déhoussable. Mécanisme facile à utiliser permettant de soulever manuellement le coussin du dossier sans se lever.

**DE** Untergestell aus Stahlrohr mit 10 Jahren Garantie. Polsterung aus Polyurethan-Schaum unterschiedlicher Dichte mit Wattierung aus Acrylfaser. Federung der Sitzflaeche aus Federstahl. Armlehnen aus Kaltschaum-Polyurethan. Sitz- und Rückenklissen aus Polyurethan-Schaum unterschiedlicher Dichte mit heiss geklebter Acryl-Vliesabdeckung. Die Elemente sind komplett abziehbar. Die Rueckenlehne hat einen einfachen Mechanismus, der das manuelle Anheben des Kissens im Sitzen ermöglicht.



**Cambio**













## CAMBIO



### Divani trasformabili in letto . Sofa beds . Canapés convertibles . Schlafcouchen

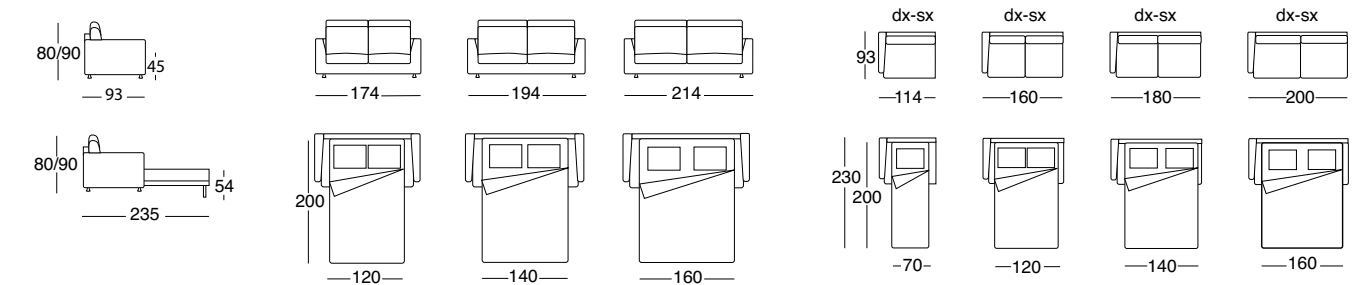

**IT** Divano trasformabile in letto completamente sfoderabile. Struttura portante in tubolare d'acciaio. Meccanica estraibile con rete elettrosaldata e plastificata. Imbottitura in Poliuretano espanso con ovattatura in fibre acriliche. Braccioli schiumati a freddo in Poliuretano espanso. Cuscini seduta e schienale in Poliuretano espanso a quote differenziate rivestiti in falda acrilica termolegata. Materasso H. cm. 13 a molle. Su richiesta il materasso può essere fornito in Polilatex.

**EN** Sofa bed with fully removable cover. Steel tube-shaped main structure. Extractable mechanism with an electrically welded plastic-coated base. Polyurethane foam padding covered in acrylic fibre wadding. Cold foamed arms filled with Polyurethane foam. Different density polyurethane foam seat and back cushions covered with a layer of heat-boned acrylic. 13 cm high spring mattress. The mattress may be supplied to order in Polilatex HT with natural latex.

**FR** Canapé convertible. Entièrement déhoussable. Structure portante en tubulaire d'acier. Mécanisme escamotable avec sommier électrosoudé plastifié. Garnissage en polyuréthane expansé avec garniture en fibre acrylique. Accoudoirs rembourrés avec des mousses à froid en polyuréthane expansé. Coussins assise et dossier en polyuréthane expansé à cotes différenciées, recouverts en fibre acrylique thermoliée. Matelas à ressorts de 13 cm. En option, le matelas peut être fourni en Polilatex.

**DE** Schlafcouch komplett abziehbar. Korpus aus Stahlrohr. Mechanismus für ausziehbaren elektrogewessten und plastifizierten Sprungrahmen. Polsterung aus Polyurethan-Schaum mit Acryl-Vliesabdeckung. Armlehnen aus Polyurethan-Kaltschaum. Sitz- und Rückenissen aus Polyurethan-Schaum unterschiedlicher Dichte mit heiss geklebter Acrylvliesabdeckung. Federkernmatratze H 13cm. Auf Wunsch kann die Matratze auch in Poylatex geliefert werden.

### Poltrona e divani fissi . Sofas and armchairs . Fauteuil et canapés fixes . Sessel und normale Sofas

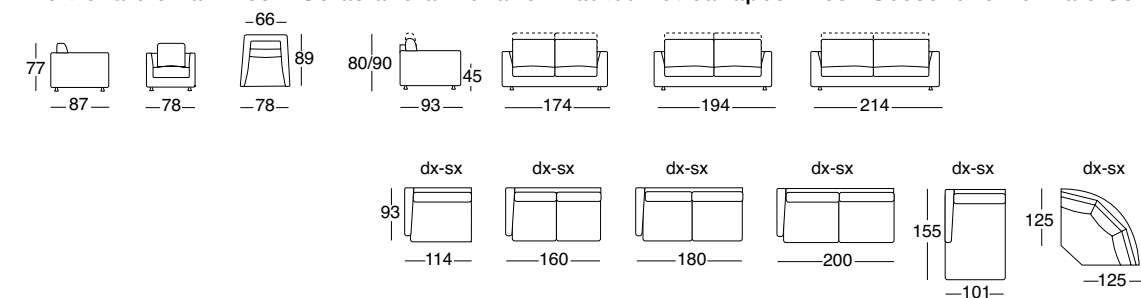

**IT** Struttura portante in tubolare di acciaio garantito 10 anni. Imbottitura in Poliuretano espanso a quote differenziate con ovattatura in fibre acriliche. Molleggio seduta in acciaio armonico. Braccioli schiumati a freddo in Poliuretano espanso. Cuscini seduta e schienali in Poliuretano espanso a quote differenziate rivestiti in falda acrilica termolegata. Elementi completamente sfoderabili. Lo schienale è dotato di un semplice meccanismo che permette il sollevamento manuale del cuscino restando seduti.

**EN** 10 years guaranteed steel tube-shaped main structure. Polyurethane foam padding covered in acrylic fibre wadding. The spring system of the seats is in harmonious steel. Cold foamed arms with polyurethane foam seat and back cushions are covered with a layer of heat-boned acrylic. Fully removable covers. The back is equipped with a simple mechanism that enables manual lifting of the back cushion when seated.

**FR** Structure portante en tubulaire d'acier garantie 10 ans. Garnissage en polyuréthane expansé à cotes différenciées avec garniture en fibre acrylique. La suspension est réalisée en acier harmonique. Accoudoirs rembourrés avec des mousses à froid en polyuréthane expansé. Coussins assise et dossier en polyuréthane expansé à cotes différenciées, recouverts en fibre acrylique thermoliée. Entièrement déhoussable. Mécanisme facile à utiliser permettant de soulever manuellement le coussin du dossier sans se lever.

**DE** Untergestell aus Stahlrohr mit 10 Jahren Garantie. Polsterung aus Polyurethan-Schaum unterschiedlicher Dichte mit Wattierung aus Acrylfaser. Federung der Sitzfläche aus Federstahl. Armlehnen aus Kaltschaum-Polyurethan. Sitz- und Rückenissen aus Polyurethan-Schaum unterschiedlicher Dichte mit heiss geklebter Acrylvliesabdeckung. Die Elemente sind komplett abziehbar. Die Rückenlehne hat einen einfachen Mechanismus, der das manuelle Anheben des Kissens im Sitzen ermöglicht.





**Libero**







## LIBERO



### Divani trasformabili in letto . Sofa beds . Canapés convertibles . Schlafcouchen

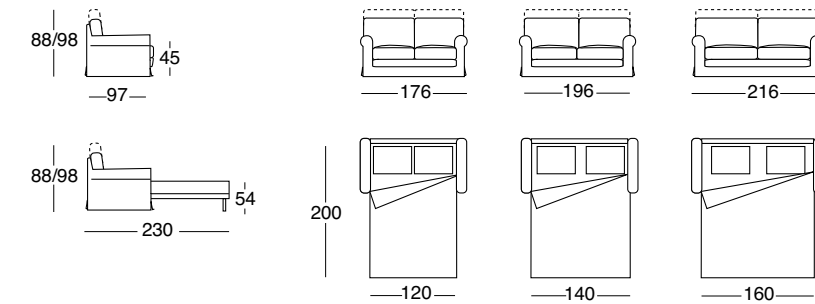

**IT** Divano trasformabile in letto completamente sfoderabile. Struttura portante in tubolare d'acciaio. Meccanica estraibile con rete elettrosaldata e plastificata. Imbottitura in Poliuretano espanso con ovattatura in fibre acriliche. Braccioli schiumati a freddo in Poliuretano espanso. Cuscini seduta e schienale in Poliuretano espanso a quote differenziate rivestiti in falda acrilica termolegata. Materasso H. cm. 13 a molle. Su richiesta il materasso può essere fornito in Polilatex.

**EN** Sofa bed with fully removable cover. Steel tube-shaped main structure. Extractable mechanism with an electrically welded plastic-coated base. Polyurethane foam padding covered in acrylic fibre wadding. Cold foamed arms filled with Polyurethane foam. Different density polyurethane foam seat and back cushions covered with a layer of heat-boned acrylic. 13 cm high spring mattress. The mattress may be supplied to order in Polilatex with natural latex.

**FR** Canapé convertible. Entièrement déhoussable. Structure portante en tubulaire d'acier. Mécanisme escamotable avec sommier électrosoudé plastifié. Garnissage en polyuréthane expansé avec garniture en fibre acrylique. Accoudoirs rembourrés avec des mousses à froid en polyuréthane expansé. Coussins assise et dossier en polyuréthane expansé à cotes différenciés, recouverts en fibre acrylique thermoliée. Matelas à ressorts de 13 cm. En option, le matelas peut être fourni en Polilatex.

**DE** Schlafcouch 140/160 cm, komplett abziehbar. Korpus aus Stahlrohr, Federung mit Holzplattenrost. Polsterung aus Polyurethan-Schaum mit Acrylvliesabdeckung. Rückenlehne mit kanalierter Gaensedaune. Matratze H 11cm aus Polyurethan-Schaum unterschiedlicher Dichte. Auf Wunsch kann die Matratze auch in Polilatex geliefert werden.

### Poltrona e divani fissi . Sofas and armchairs . Fauteuil et canapés fixes . Sessel und normale Sofas

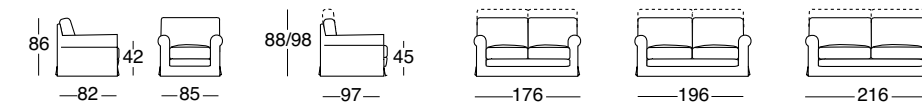

**IT** Struttura portante in tubolare di acciaio garantito 10 anni. Imbottitura in Poliuretano espanso a quote differenziate con ovattatura in fibre acriliche. Molleggio seduta in acciaio armonico. Braccioli schiumati a freddo in Poliuretano espanso. Cuscini seduta e schienali in Poliuretano espanso a quote differenziate rivestiti in falda acrilica termolegata. Elementi completamente sfoderabili. Lo schienale è dotato di un semplice meccanismo che permette il sollevamento manuale del cuscino restando seduti.

**EN** 10 years guaranteed steel tube-shaped main structure. Polyurethane foam padding covered in acrylic fibre wadding. The spring system of the seats is in harmonious steel. Cold foamed arms with polyurethane foam. Different density polyurethane foam seat and back cushions are covered with a layer of heat-boned acrylic. Fully removable covers. The back is equipped with a simple mechanism that enables manual lifting of the back cushion when seated.

**FR** Structure portante en tubulaire d'acier garantie 10 ans. Garnissage en polyuréthane expansé à cotes différenciées avec garniture en fibre acrylique. La suspension est réalisée en acier harmonique. Accoudoirs rembourrés avec des mousses à froid en polyuréthane expansé. Coussins assise et dossier en polyuréthane expansé à cotes différenciés, recouverts en fibre acrylique thermoliée. Entièrement déhoussable. Mécanisme facile à utiliser permettant de soulever manuellement le coussin du dossier sans se lever.

**DE** Untergestell aus Stahlrohr mit 10 Jahren Garantie. Polsterung aus Polyurethan-Schaum unterschiedlicher Dichte mit Wattierung aus Acrylfaser. Federung der Sitzfläche aus Federstahl. Armlehnen aus Kältschaum-Polyurethan. Sitz- und Rückenissen aus Polyurethan-Schaum unterschiedlicher Dichte mit heiss geklebter Acrylvliesabdeckung. Die Elemente sind komplett abziehbar. Die Rückenlehne hat einen einfachen Mechanismus, der das manuelle Anheben des Kissens im Sitzen ermöglicht.





**Memo**











**MEMO**



**Divani trasformabili in letto . Sofa beds . Canapés convertibles . Schlafcouchen**

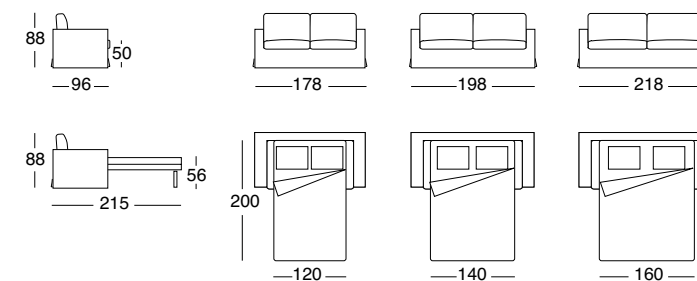

**IT** Divano trasformabile in letto completamente sfoderabile. Struttura portante in tubolare d'acciaio. Meccanica estendibile con rete elettrosaldata e plastificata. Imbottitura in Poliuretano espanso con ovattatura in fibre acriliche. Cuscini seduta e schienale in Poliuretano espanso a quote differenziate rivestiti in falda acrilica termolegata. Materasso H. cm. 13 a molle. Su richiesta il materasso può essere fornito in Pollatex.

**EN** Sofa bed with fully removable cover. Steel tube-shaped main structure. Extendible mechanism with an electrically welded plastic-coated base. Polyurethane foam padding covered in acrylic fibre wadding. Different density polyurethane foam seat and back cushions covered with a layer of heat-boned acrylic. 13 cm high spring mattress. The mattress may be supplied to order in Pollatex HT with natural latex.

**FR** Canapé convertible. Entièrement déhoussable. Structure portante en tubulaire d'acier. Mécanisme extensible avec sommier électrosoudé plastifié. Garnissage en polyuréthane expansé avec garniture en fibre acrylique. Coussins assise et dossier en polyuréthane expansé à cotes différenciés, recouverts en fibre acrylique thermoliée. Matelas à ressorts de 13 cm. En option, le matelas peut être fourni en Pollatex.

**DE** Schlafcouch komplett abziehbar. Korpus aus Stahlrohr. Ausziehmechanismus mit elektrogewebtem und plastifiziertem Sprungrahmen. Polsterung aus Polyurethan-Schaum mit Acrylfliesabdeckung. Sitz- und Rückenissen in Polyurethan-Schaum mit heiss geklebter Acrylfliesabdeckung. Federkernmatratze H 13 cm. Auf Wunsch kann die Matratze in Polyatex geliefert werden.





**Boboli**











## BOBOLI



Poltrona e divani trasformabili in letto . Armchair and sofa beds . Auteuil et canapés convertibles . Schlafessel und Schlafcouchen

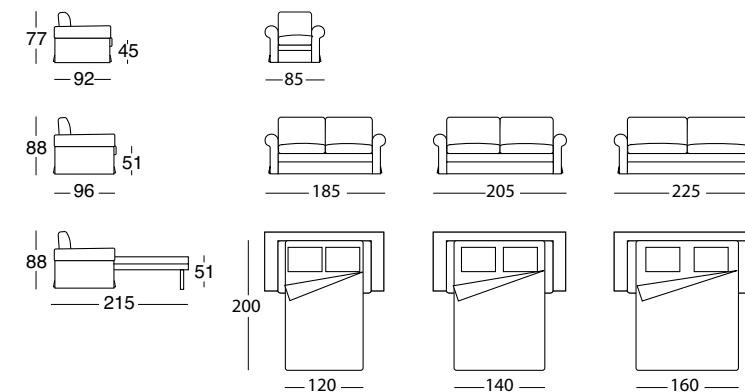

**IT** Divano trasformabile in letto completamente sfoderabile. Struttura portante in tubolare d'acciaio. Meccanica estendibile con rete elettrosaldata e plastificata. Imbottitura in Poliuretano espanso con ovattatura in fibre acriliche. Cuscini seduta e schienale in Poliuretano espanso a quote differenziate rivestiti in falda acrilica termolegata. Materasso H. cm. 13 a molle. Su richiesta il materasso può essere fornito in Polilatex.

**EN** Sofa bed with fully removable cover. Steel tube-shaped main structure. Extendible mechanism with an electrically welded plastic-coated base. Polyurethane foam padding covered in acrylic fibre wadding. Different density polyurethane foam seat and back cushions covered with a layer of heat-boned acrylic. 13 cm high spring mattress. The mattress may be supplied to order in Polilatex HT with natural latex.

**FR** Canapé convertible cm.140/160. Entièrement déhoussable. Structure portante en tubulaire d'acier. Suspension avec lattes en bois. Garnissage en polyuréthane expansé avec garniture en fibre acrylique. Coussins du dossier en duvet cloisonné. Matelas en polyuréthane expansé à cotes différenciées de 11 cm. En option, le matelas peut être fourni en Polilatex.

**DE** Schlafcouch komplett abziehbar. Korpus aus Stahlrohr. Ausziehmechanismus mit elektrogeschweisstem und plastifiziertem Sprungrahmen. Polsterung aus Polyurethan-Schaum mit Acrylvliesabdeckung. Sitz- und Rückenissen in Polyurethan-Schaum mit heiss geklebter Acrylvliesabdeckung. Federkernmatratze H 13 cm. Auf Wunsch kann die Matratze in Polyilatex geliefert werden.





**Ghost**













## GHOST

Divani trasformabili in letto . Sofa beds . Canapés convertibles . Schlafcouchen

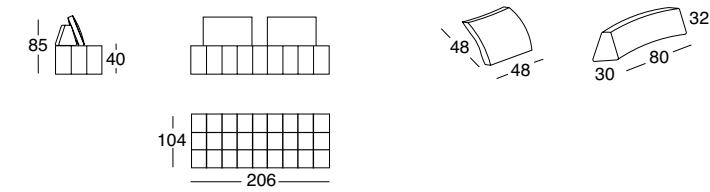

Materasso . Mattress . Matelas . Matratze

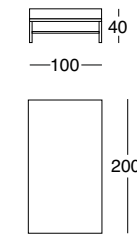

**IT** Divano trasformabile in letto singolo completamente sfoderabile. La struttura portante in tubolare di acciaio con rete elettrosaldata. Imbottitura in Poliuretano espanso a quote differenziate con ovattatura in fibra acrilica, struttura rifinita in ecopelle. Schienali in Poliuretano espanso zavorrati, per sostenere l'appoggio stabile e fisso in qualsiasi posizione vengano collocati. Cuscino schienale in piuma d'oca canalizzata. Materasso H. cm. 13 in Poliuretano espanso a quote differenziate. Su richiesta il materasso può essere fornito in Pollatex. Fornito di trapunta e lenzuola di cotone bianco.

**EN** Sofa bed with single bed. Fully removable cover. Steel tube-shaped main structure with electrically welded base. Different density polyurethane foam padding covered in acrylic fibre wadding. Structure perfected in eco-friendly leather. The back cushions are in polyurethane foam. They are ballasted in order to remain stable and fixed in any position. Baffled down back cushions. 13 cm high mattress in polyurethane foam of different densities. The mattress may be supplied to order in Pollatex HT with natural latex. The bed set comes complete with white cotton sheets and a quilt.

**FR** Canapé convertible en lit à une place. Entièrement déhoussable. Structure portante en tubulaire d'acier avec un sommier électrosoudé. Garnissage en polyuréthane expansé à cotes différenciées avec garniture en fibre acrylique, structure en similicuir. Dossiers en polyuréthane expansé. Ils sont lourds et ils restent stables et fixes, quelle que soit leur position. Coussins du dossier en duvet cloisonné. Matelas de 13 cm en polyuréthane expansé à cotes différenciés. En option, le matelas peut être fourni en Pollatex. Le lit est livré avec une couette et un drap de lit en coton blanc.

**DE** Schlafcouch als Einzelbett, komplett abziehbar. Das Untergestell ist aus Stahlrohr mit elektrogeschweisstem Sprungrahmen. Polsterung aus Polyurethan-Schaum unterschiedlicher Dichte mit Acrylmiesabdeckung, Korpus mit Kunstleder bezogen. Rückenlehnen aus beschwerterem Polyurethan-Schaum, um eine stabile und feste Stütze in jeder Position zu erhalten. Rückenkissen mit kanalisierter Gänseedaune. Matratze H 13cm in Polyurethan-Schaum unterschiedlicher Dichte. Auf Wunsch kann die Matratze in Polyatex geliefert werden. Ausgestattet mit Steppdecke und Laken aus weissem Kunststoff.



**Slalom**











## SLALOM



Divani trasformabili in letto . Sofa beds . Canapés convertibles . Schlafcouchen

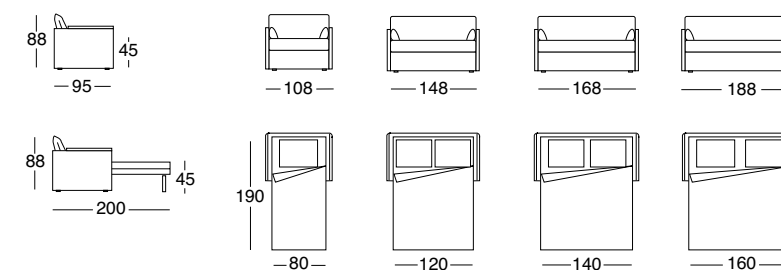

**IT** Divani e poltrone trasformabili in letto, completamente sfoderabili. Struttura portante in tubolare di acciaio. Meccanica rete estendibile con doghe di legno. Imbottitura in poliuretano espanso con ovattatura in fibre acriliche. Materasso H. cm. 11 in poliuretano espanso rivestito con falda acrilica. Su richiesta il materasso può essere fornito in Polilatex. Fornito di trapunta e lenzuola di cotone bianco.

**EN** Sofa beds and armchair bed with fully removable covers. Steel tube-shaped main structure. Extendible mechanism with wooden slats. Polyurethane foam padding covered in acrylic fibre wadding. 11 cm high polyurethane foam mattress covered with a layer of acrylic. The mattress may be supplied to order in Polilatex HT with natural latex. The bed set comes complete with white cotton quilt and sheets.

**FR** Canapés et fauteuils convertibles. Entièrement déhoussables. Structure portante en tubulaire d'acier. Mécanisme extensible avec lattes en bois. Garnissage en polyuréthane expansé avec garniture en fibre acrylique. Matelas de 11 cm en polyuréthane expansé recouvert en fibre acrylique. En option, le matelas peut être fourni en Polilatex. Le lit est livré avec une couette et un drap de lit en coton blanc.

**DE** Schlafcouchen und Schlafsessel, komplett abziehbar. Untergestell aus Stahlrohr. Mechanik fuer ausziehbaren Holz-Lattenrost. Polsterung aus Polyurethan-Schaum mit Wattierung aus Acrylmies. Matratze H 11cm aus Polyurethan-Schaum mit Acrylmiesabdeckung. Auf Wunsch kann die Matratze auch in Polylatex geliefert werden. Ausgestattet mit Steppdecke und Bettlaken aus weisser Baumwolle.



**Surf**













## SURF



Poltrona e divani trasformabili in letto . Armchair and sofa beds . Auteuil et canapés convertibles . Schlafessel und Schlafcouchen

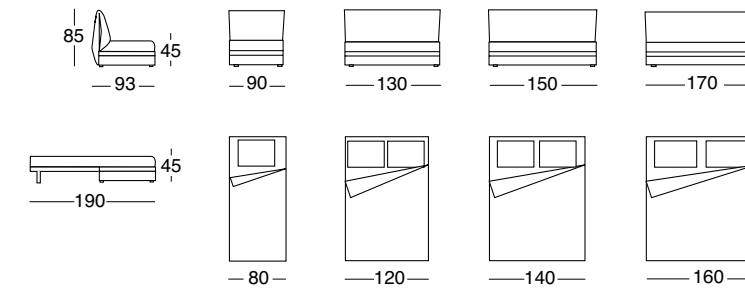

**IT** Divani e poltrone trasformabili in letto, completamente sfoderabili. Struttura portante in tubolare di acciaio. Meccanica rete estendibile con doghe di legno. Imbottitura in poliuretano espanso con ovattatura in fibre acriliche. Materasso H. cm. 11 in poliuretano espanso rivestito con falda acrilica. Su richiesta il materasso può essere fornito in Polilatex. Fornito di trapunta e lenzuola di cotone bianco.

**EN** Sofa beds and armchair bed with fully removable covers. Steel tube-shaped main structure. Extendible mechanism with wooden slats. Polyurethane foam padding covered in acrylic fibre wadding. 11 cm high polyurethane foam mattress covered with a layer of acrylic. The mattress may be supplied to order in Polilatex HT with natural latex. The bed set comes complete with white cotton quilt and sheets.

**FR** Canapés et fauteuils convertibles. Entièrement déhoussables. Structure portante en tubulaire d'acier. Mécanisme extensible avec lattes en bois. Garnissage en polyuréthane expansé avec garniture en fibre acrylique. Matelas de 11 cm en polyuréthane expansé recouvert en fibre acrylique. En option, le matelas peut être fourni en Polilatex. Le lit est livré avec une couette et un drap de lit en coton blanc.

**DE** Schlafcouchen und Schlafessel, komplett abziehbar. Untergestell aus Stahlrohr. Mechanik fuer ausziehbaren Holz-Lattenrost. Polsterung aus Polyurethan-Schaum mit Wattierung aus Acrylvlies. Matratze H 11cm aus Polyurethan-Schaum mit Acrylvliesabdeckung. Auf Wunsch kann die Matratze auch in Polylatex geliefert werden. Ausgestattet mit Steppdecke und Bettlaken aus weisser Baumwolle.





**Carosello**







## CAROSSELLO



Poltrona e divani trasformabili in letto . Armchair and sofa beds . Auteuil et canapés convertibles . Schlafessel und Schlafcouchen

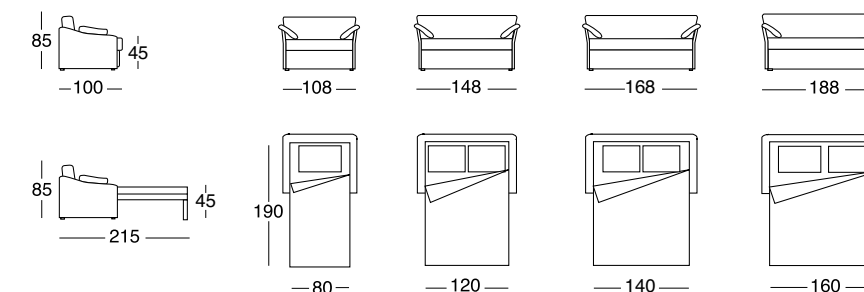

**IT** Divani e poltrone trasformabili in letto, completamente sfoderabili. Struttura portante in tubolare di acciaio. Meccanica rete estendibile con doghe di legno. Imbottitura in poliuretano espanso con ovattatura in fibre acriliche. Materasso H. cm. 11 in poliuretano espanso rivestito con falda acrilica. Su richiesta il materasso può essere fornito in Polilatex. Fornito di trapunta e lenzuola di cotone bianco.

**EN** Sofa beds and armchair bed with fully removable covers. Steel tube-shaped main structure. Extendible mechanism with wooden slats. Polyurethane foam padding covered in acrylic fibre wadding. 11 cm high polyurethane foam mattress covered with a layer of acrylic. The mattress may be supplied to order in Polilatex HT with natural latex. The bed set comes complete with white cotton quilt and sheets.

**FR** Canapés et fauteuils convertibles. Entièrement déhoussables. Structure portante en tubulaire d'acier. Mécanisme extensible avec lattes en bois. Garnissage en polyuréthane expansé avec garniture en fibre acrylique. Matelas de 11 cm en polyuréthane expansé recouvert en fibre acrylique. En option, le matelas peut être fourni en Polilatex. Le lit est livré avec une couette et un drap de lit en coton blanc.

**DE** Schlafcouchen und Schlafessel, komplett abziehbar. Untergestell aus Stahlrohr. Mechanik fuer ausziehbaren Holz-Lattenrost. Polsterung aus Polyurethan-Schaum mit Wattierung aus Acrylmies. Matratze H 11cm aus Polyurethan-Schaum mit Acrylmiesabdeckung. Auf Wunsch kann die Matratze auch in Polylatex geliefert werden. Ausgestattet mit Steppdecke und Bettlaken aus weisser Baumwolle.



**Carlotta  
plus**







**CARLOTTA PLUS**



Divani trasformabili in letto . Sofa beds . Canapés convertibles . Schlafcouchen

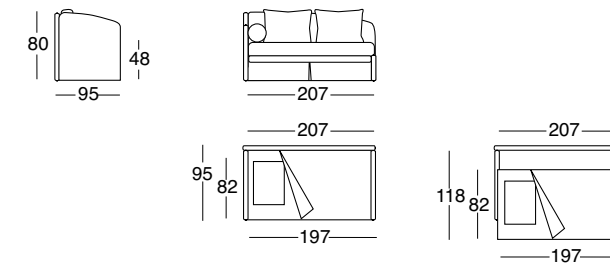

Rete supplementare . Additional bed base . Sommier supplémentaire . Zusätzlicher sprungfederrahmen

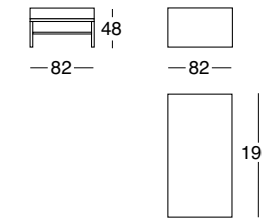

**IT** Divano trasformabile in letto singolo completamente sfoderabile. Struttura portante in legno. Imbottitura in Poliuretano espanso rivestita in fibra acrilica. I cuscini dello schienale sono in Rollfill. Rete in acciaio elettrosaldato e materasso in Poliuretano espanso H. cm. 11, rivestito con falda acrilica. Possibilità di letto supplementare. Il pronto letto viene fornito di trapunta. Su richiesta il materasso può essere fornito in Polilatex.

**EN** Sofa bed with single bed. Fully removable cover. Wooden main structure. Polyurethane foam padding covered in double acrylic fibre. The back cushions are made of Rollfill. Electrically welded steel base and H. cm. 11 high polyurethane foam mattress, covered with a layer of acrylic. Possibility of twin bed with an extra electrically welded steel base. The bed set comes complete with a quilt. The mattress may be supplied to order in Polilatex HT with natural latex.

**FR** Canapé convertible en lit à une place. Entièrement déhoussable. Structure portante en bois. Garnissage en polyuréthane expansé, recouvert en fibre acrylique. Les coussins du dossier sont en Rollfill. Sommier en acier électrosoudé et matelas en polyuréthane expansé de 11 cm, recouvert en fibre acrylique. Possibilité de lit supplémentaire. Le lit est livré avec une couette. En option, le matelas peut être fourni en Polilatex.

**DE** Schlafcouch als Einzelbett komplett abziehbar. Untergestell aus Holz. Polsterung aus Polyurethan-Schaum mit Acrylvliesabdeckung. Die Rueckenkissen sind aus Rollfill. Sprungrahmen aus elektrogewweißtem Stahl mit Matratze aus Polyurethan-Schaum H 11cm mit Acrylvliesabdeckung. Ein zusätzliches Bett ist möglich. Das fertige Bett wird mit Steppdecke geliefert. Auf Wunsch kann die Matratze in Polyilatex geliefert werden.





**Carletto  
plus**







## CARLETTO PLUS



Divani trasformabili in letto . Sofa beds . Canapés convertibles . Schlafcouchen

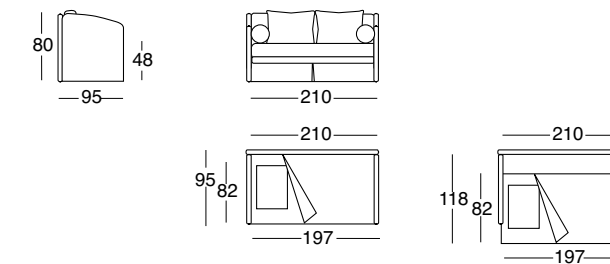

Rete supplementare . Additional bed base . Sommier supplémentaire . Zusätzlicher sprungfederrahmen

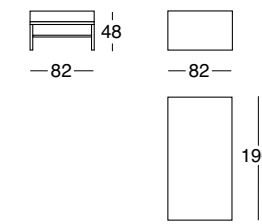

**IT** Divano trasformabile in letto singolo completamente sfoderabile. Struttura portante in legno. Imbottitura in Poliuretano espanso rivestita in fibra acrilica. I cuscini dello schienale sono in Rollfill. Rete in acciaio elettrosaldato e materasso in Poliuretano espanso H. cm. 11, rivestito con falda acrilica. Possibilità di letto supplementare. Il pronto letto viene fornito di trapunta. Su richiesta il materasso può essere fornito in Polilatex.

**EN** Sofa bed with single bed. Fully removable cover. Wooden main structure. Polyurethane foam padding covered in double acrylic fibre. The back cushions are made of Rollfill. Electrically welded steel base and H. cm. 11 high polyurethane foam mattress, covered with a layer of acrylic. Possibility of twin bed with an extra electrically welded steel base. The bed set comes complete with a quilt. The mattress may be supplied to order in Polilatex HT with natural latex.

**FR** Canapé convertible en lit à une place. Entièrement déhoussable. Structure portante en bois. Garnissage en polyuréthane expansé, recouvert en fibre acrylique. Les coussins du dossier sont en Rollfill. Sommier en acier électrosoudé et matelas en polyuréthane expansé de 11 cm, recouvert en fibre acrylique. Possibilité de lit supplémentaire. Le lit est livré avec une couette. En option, le matelas peut être fourni en Polilatex.

**DE** Schlafcouch als Einzelbett komplett abziehbar. Untergestell aus Holz. Polsterung aus Polyurethan-Schaum mit Acrylvliesabdeckung. Die Rückenissen sind aus Rollfill. Sprungrahmen aus elektrogeschweisstem Stahl mit Matratze aus Polyurethan-Schaum H 11cm mit Acrylvliesabdeckung. Ein zusätzliches Bett ist möglich. Das fertige Bett wird mit Steppdecke geliefert. Auf Wunsch kann die Matratze in Polylatex geliefert werden.



**Pluto**







**PLUTO**



Pouff trasformabile in letto . Pouf bed . Pouf convertible . Auszieh-Polsterelement

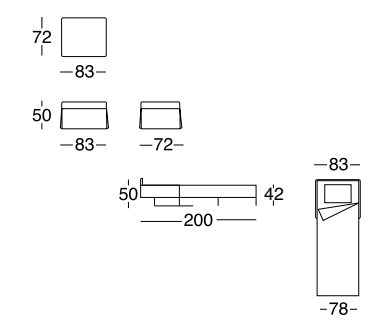

**IT\_**Pouff trasformabile in letto singolo con semplice meccanismo. Rete elettrosaldata. Completamente sfoderabile. Materasso in poliuretano espanso H. cm. 11. Su richiesta il materasso può essere fornito in Polilatex.

**EN\_**Pouf with simple mechanism for transformation into a single bed. Electrically welded base. Fully removable cover. 11 cm high polyurethane foam mattress. The mattress may be supplied to order in Polilatex HT with natural latex.

**FR\_**Pouf convertible en lit à une place, grâce à un mécanisme tout simple. Sommier électrosoudé. Entièrement déhoussable. Matelas de 11 cm en polyuréthane expansé. En option, le matelas peut être fourni en Polilatex.

**DE\_**Pouf als Einzelbett mit einfachem Mechanismus. Elektrogeschweisster Sprungrahmen. Komplet abziehbar Matratze aus Polyurethan-Schaum H 11cm. Auf Wunsch kann die Matratze in Polylatex geliefert werden.





## LEONARDO

### Testata . Headboard . Tête . Bettkopf

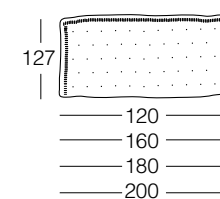

Colori cucitura a contrasto . Thread colours for contrasting stitching . Couleurs du fil pour couture contrastée . Garnfarben für die Kontrastnaht



**IT** Testata imbottita con fibra acrilica. Finitura punto cavallo su tre lati. Punti cuciti effetto capitonné. Per il montaggio viene fornita un'asta tubolare verniciata con relativi tasselli e ganci.

**EN** Padded headboard acrylic fibre. Finished with blanket stitch on three sides. Stitch sewed with capitonné effect. For assembling a tube-shaped beam with dowels and hooks will be furnished.

**FR** Tête de lit rembourrée avec fibres acryliques. Couture point de cheval sur trois côtés. Couture avec effet capitonné. Pour le montage elle sera fournie d'une perche tubulaire avec ses ancrés et crochets.

**DE** Bettkopf gepolstert mit Acrylfase. Ziernaehnte an drei Seiten. Abgesteppt mit Capitonné-Effekt. Fuer die Montage wird eine lackierte Rohrstange mit entsprechenden Haken und Oesen geliefert.

# Arnò

STRUTTURA\_FRAME\_STRUCTURE\_RAHMEN



# Boboli Memo

STRUTTURA\_FRAME\_STRUCTURE\_RAHMEN





# Cambio Elio Libero Metronotte

STRUTTURA\_FRAME\_STRUCTURE\_RAHMEN



# Carosello Slalom Surf

STRUTTURA\_FRAME\_STRUCTURE\_RAHMEN



**Dema**  
FIRENZE

Via Arno, 7  
I-50025 Martignana  
Montespertoli (Fi)  
Tel. +39 0571 676027  
Fax +39 0571 676248  
info@dema.it  
www.dema.it

Export Department

G R U P P O  
**GIMO**

56035 Perignano (Pisa) Italia  
Tel. +39 0587 736062 \_Fax +39 0587 736059  
gimo@gimo.it \_www.gimo.it

Dema® si riserva di apportare, senza preavviso, modifiche nei materiali, nei rivestimenti, nelle finiture dei prodotti presentati in questo catalogo. I colori dei materiali e delle finiture hanno un valore indicativo in quanto soggetti alle tolleranze dei processi di stampa.

Dema® reserves the right to make modifications to the materials, coatings, finishes of the products presented in this catalogue without prior warning. The colours of the materials and finishes are purely an indication as they may differ slightly due to the printing processes.

Dema® se réserve le droit d'apporter des modifications aux matériaux, aux revêtements et aux finitions des produits présentés dans ce catalogue sans préavis. Les couleurs des matériaux et des finitions sont données à titre indicatif, car elles sont sujettes aux tolérances des processus d'impression.

Dema® behält sich vor, jederzeit ohne Ankündigung Änderungen an den Materialien, Bezügen und Oberflächen der in diesem Katalog vorgestellten Produkte vorzunehmen. Die Farben der Materialien und der Oberflächen sind mit den unvermeidlichen Toleranzen wiedergegeben, die durch die Druckvorgänge bedingt sind.